

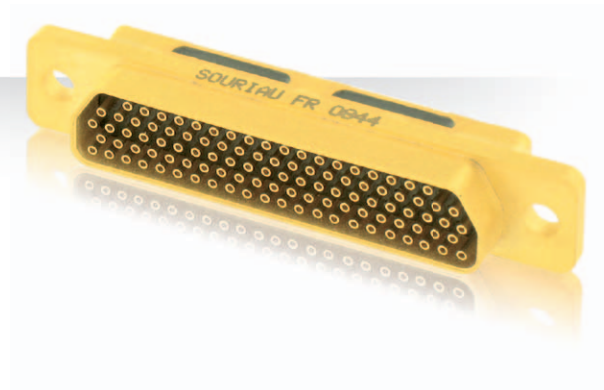

Miniature Lightweight High Density Connectors Space Grade - ESA QPL



Contents

Overview	4
Features and benefits	6
Comparison with micro-D	7
Comparison with high density D-Sub	8
Technical Features	9 - 11
Weight - Mating Forces	12
Qualified following ESA procedure.....	13
Quality levels and controls.....	14
Lot acceptance tests.....	15
Contact layouts	16
Contact types	17
Ordering information	18 - 19
Crimp removable contacts	20
Mating dimensions and contact position	21
Wiring instructions	22
Dimensions	23 - 25
Mounting operations and hardware	26 - 31
PCB drilling	32
Mounting hardware	33 - 37
Savers	41 - 42
EMI Backshells	43 - 48
Dust Caps	49



Overview

Description



To respond to miniaturization and weight saving trends in space applications SOURIAU has developed, at the request of the European Space Agency (ESA) an innovative high density connector range: *microComp*® is the alternative to High Density D-Sub and micro-D.

- ESA QPL
- Shell in composite: very light and non magnetic
- Save up to 65% in weight compared to HD D-Sub
- High density: save more than 40% in size compared to HD D-Sub
- Crimp removable contacts : repairable harnesses
- High vibration and shock withstanding
- Non-outgassing
- Low mating/unmating force



Applications

- For communication, military, observation and science satellites equipment:
 - Power Distribution Unit
 - Solar panel
 - Satellite camera
 - Avionics
 - Battery management
 - PIU/ PLIU (Payload interface units)
 - SMU (Satellite management unit)
 - Star tracker...
- For micro satellites and probes
- For Launcher :
 - Test benches
 - Engine control Unit

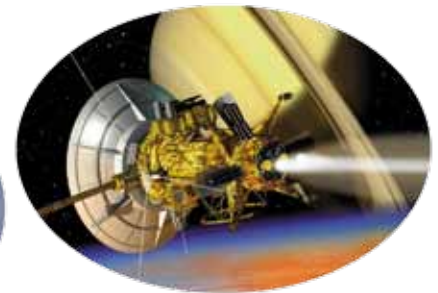

... and any electronic device with space and weight constraints.



For MIL/Aero applications consult our dedicated Aeronautical and Defense *microComp*® catalog.



SOURIAU: a specialist in space connection technology

Souriau is ESA (European Space Agency) qualified since 1988.

Today Souriau is ESA QPL for:

- microComp®
- D-Sub (Standard and High Density)
- MIL-DTL 38999

Strength of ESA system:

- These qualifications are reviewed every 2 years, according to ESCC basic specification 20100.
- Any change in manufacturing process is submitted to ESA approval. Manufacturing processes are fully recorded in a PID (Process Identification Document).

Souriau is GSFC (NASA) qualified since 1992.

Today Souriau is GSFC QPL for D-Sub (Standard and High density)

microComp® is ESA QPL



Qualified to ESA (European Space Agency) generic specifications 3401 Chart IV and microComp® specifications:

These specifications are available on ESA SCC web site:

3401	Generic Specification for connectors electrical Circular and Rectangular	https://escies.org/escs/specifications/3401.pdf
3401081	Connectors, electrical, rectangular, microminiature, gauge 26 PCB Pin Contacts, based on type microComp®	https://escies.org/escs/specifications/3401081.pdf
3401082	Connectors, electrical, rectangular, microminiature, removable gauge 26 crimp contacts, based on type microComp®	https://escies.org/escs/specifications/3401082.pdf
3401083	Contacts, electrical, gauge 26, for 3401/082 connectors	https://escies.org/escs/specifications/3401083.pdf
3401084	Accessories for rectangular connectors, microminiature 3401/081 and 3401/082	https://escies.org/escs/specifications/3401084.pdf



Features and benefits

Composite shell benefits

microComp® shells are available in glass fiber reinforced themoplastic material for maximum mechanical resistance. Composite shells are up to 36% lighter than their equivalent in aluminum and are non-magnetic by nature. The advanced “Gold over composite” plating process used on microComp® provides optimized shielding and shell-to-shell continuity and is the result of years of R&D.

microComp® pins are protected

microComp® male connectors are "damage proof". On HD D-Sub and D-Sub male contacts are the fragile parts of the connector because they can easily be bent. On microComp® male contacts are fully shrouded by the insulator: they are protected and can't be bent.

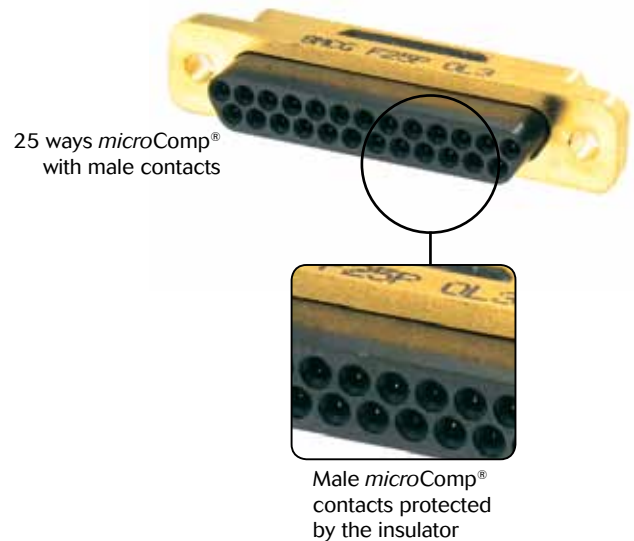
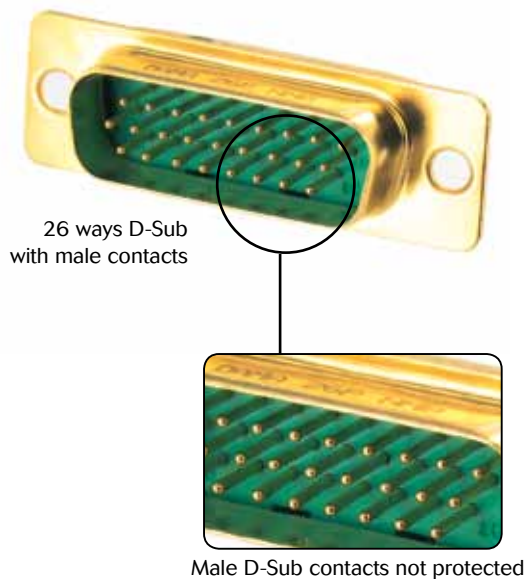

microComp® for high speed network

Thanks to short contacts and good EMI performances microComp® can be used for Cat 5e Gigabit Ethernet 1000 base T links.

Contact us for more information about wiring for Ethernet: microcomp@souriau.com

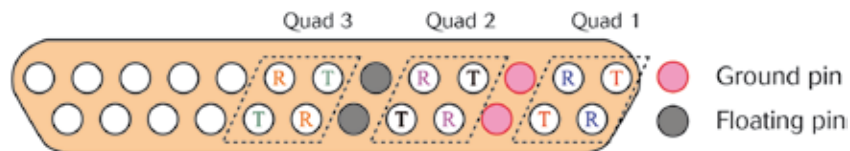



Comparison with micro-D

microComp® benefits:

Save money: global cost of ownership is less expensive for *microComp*® than for micro-D. With micro-D any change in design or quality issue leads to complete harness replacement as micro-D are pre-wired and non repairable. *microComp*® solution is more flexible thanks to the removable crimp contacts.

Save time in development: *microComp*® has removable crimp contacts so you can easily and quickly change your harness configuration.

Save weight: the high technology composite shells (strengthened fiber glass material for maximum mechanical resistance) makes *microComp*® very light and robust.

Same panel cut-out: *microComp*® connectors have the same external dimensions as MIL-DTL 83513 (except for size H and J).

Easier to use: mating and unmating force is lower for *microComp*® than for micro-D.

Weight comparison: → *microComp*® is lighter

Comparison between the max weight (connector + contacts) given in *microComp*® standard (ESCC 3401/081, 082, 083) and in micro-D standard (ESCC 3401/029).

	<i>microComp</i> ®	micro-D	<i>microComp</i> ®	micro-D	<i>microComp</i> ®	micro-D
Number of contacts	7	9	25	25	51	51
Plug without cable	1,42 gr	2,20 gr	3,60 gr	4,30 gr	6,01 gr	7,20 gr
Receptacle with 90° spills	1,68 gr	7,40 gr	4,60 gr	10,20 gr	8,39 gr	16,50 gr
Average weight per contact	0,44 gr	1,07 gr	0,33 gr	0,58 gr	0,28 gr	0,46 gr
Weight saved per contact with <i>microComp</i> ® (%)	- 58%		- 43%		- 39%	

Mating force comparison: → *microComp*® is easier to mate and unmate

even with more than 100 contacts.

Comparison between the max mating and unmating force given in *microComp*® standard (ESCC 3401/081, 082, 083) and in micro-D standard (ESCC 3401/029 for sizes 9, 25, 51. MIL-DTL 83513 for size 100 because there is no micro-D space standard for size 100).

	<i>microComp</i> ®	micro-D	<i>microComp</i> ®	micro-D	<i>microComp</i> ®	micro-D	<i>microComp</i> ®	micro-D
Number of contacts	7	9	25	25	51	51	104	100
Max mating/unmating force (N)	12N	20N	43N	55N	87N	113N	179N	283N
Difference in N	8N		13N		26N		104N	
Saving in %	- 41%		- 23%		- 23%		- 37%	



Comparison with high density D-Sub

microComp® benefits:

Save room and weight on your equipment: for signal applications, replace your HD D-Sub with microComp® and reduce your equipment dimensions and weight.

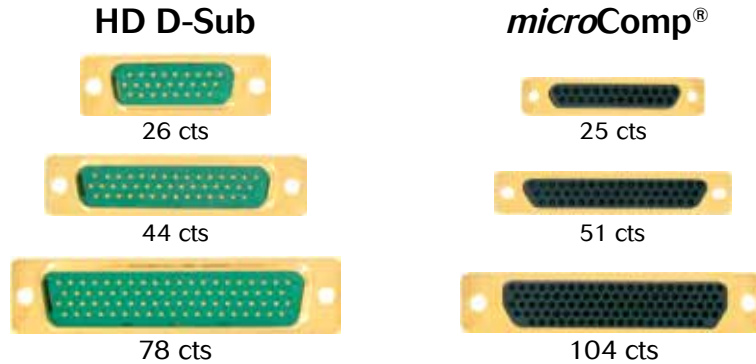

Size comparison: microComp® is smaller

Comparison between the max dimensions given in microComp® standard (ESCC 3401/081) and in HD D-Sub space standard (ESA ESCC 3401 001/002/005, NASA GSFC S-311-P-4D).

	microComp®	HD-DSub	microComp®	HD-DSub	microComp®	HD-DSub
Number of contacts	25	26	51	44	104	78
Front dimension (max)	2,9 cm ²	5,1 cm ²	4,3 cm ²	6,9 cm ²	7,8 cm ²	12,1 cm ²
Size saving / HD Dsub	– 42%		– 37%		– 35%	
Surface per contact	11,8 mm ²	19,7 mm ²	8,5 mm ²	15,7 mm ²	7,5 mm ²	11,6 mm ²
Size saving per contact / HD Dsub	– 40%		– 46%		– 35%	

*ESCC only

Weight comparison: → microComp® is lighter

Comparison between the max weight given in microComp® standard (ESCC 3401/081, 082, 083) and in HD D-Sub standard ESA ESCC 3401 001/002/005 (no weight data in GSFC S-311-P-4D)

	microComp®	HD-DSub	microComp®	HD-DSub	microComp®	HD-DSub
Number of contacts	25	26	51	44	104	78
Plug without cable	3,60 gr	9,48 gr	6,01 gr	14,52 gr	10,99 gr	31,32 gr
Receptacle with 90° spills	4,60 gr	14,00 gr	8,39 gr	22,14 gr	17,54 gr	51,04 gr
Average weight per contact	0,33 gr	0,90 gr	0,28 gr	0,83 gr	0,27 gr	0,79 gr
Weight saved per contact with microComp® (%)	– 64%		– 66%		– 65%	

Mating force comparison: → microComp® is easier to mate and unmate

even with more than 100 contacts.

Comparison between the max mating/unmating force given in microComp® standart (ESCC 3401/081) and in HD D-sub space standard GSFC S-311-P-4D. (Note: ESCC max mating force are higher than GSFC).

	microComp®	HD-Dsub	microComp®	HD-Dsub	microComp®	HD-Dsub
Number of contacts	25	26	51	44	104	78
Max mating/unmating force (N)	43N	76N	87N	125N	179N	289N
Difference in N	33N		38N		110N	
Saving in %	– 44%		– 30%		– 38%	



Technical characteristics



Electrical

- Contact size: #26
- Contact pitch: 2 mm
- Current rating: 2.5 Amps
- Dielectric Withstanding Voltage
sea level: 600 VRMS
70,000 feet: 200 VRMS
- Working voltage
sea level: 150 VRMS
70,000 feet: 100 VRMS
- Insulation resistance: 5,000 MΩ
- Low level contact resistance: 6 mΩ
- Rated current contact resistance: <5 mΩ
- Admissible wire gauge: AWG 24 to 28
- Shielding effectiveness: > 60dB attenuation
from 1 to 500 MHz
- Shell to shell continuity:
Composite version: < 2mΩ
Aluminum version: < 2mΩ

Mechanical

- Endurance / Durability:
500 mating/unmating operations
- Contact retention in insert: 15 N
- Vibration:
Random: 44g (ESA requirements: 20g)
Sine: 20g
- Shock: 50g

Climatic

- Operating temperature range:
-55°C to +175°C
(ESA requirements:
-55°C / +125°C)
- Storage temperature range
-65°C to +125°C
- Soldering temperature: +260°C
- Salt spray (corrosion):
Composite shell = 2000 hrs
Aluminum shell = 48 hrs

Environmental

- RoHS: compliant

Material and finishes:

- Shell: composite (glass fiber reinforced material for maximum mechanical resistance) or Aluminum
- Shell plating: 1.27 μm (.50 μInch) Au
- Contact: copper alloy
- Contact plating: 1.27 μm (.50 μInch) Au according to Type 2, Grade C of MIL-DTL-45204. Underplate of 1.00μm (.00004 in) min of Copper or High phosphorus chemical Nickel
- Insulator: thermoplastic
- Mounting accessories (Jackscrews, jackposts, clip): stainless steel, passivated per QQ-P-35
- Grommet and seal: silicone rubber
- Drilled bar: thermoplastic

Space

- Outgassing:
1% Total Mass Loss max
1% Recovered Mass Loss max
0.1% Collected Volatile Condensable Materials
- Residual Magnetism: < 200 gamma

For more information or questions, please contact microcomp@souriau.com



Technical features

Detailed performances

Electrical		
Description	Requirement	Test method
Dielectric Withstanding Voltage (2mA leakage current max) 70,000 feet	600 VRMS	ESCC 3401 / 9.1.1.2 MIL-DTL 83513 IEC 60512 test 4a methB
Dielectric Withstanding Voltage (2mA leakage current max) 70,000 feet	200 VRMS	
Working Voltage Sea Level	150 VRMS	EIA 360-20 cond I
Working Voltage 70 000 feet	100 VRMS	EIA 360-20 cond IV
Insulation resistance	5,000 MΩ	ESCC 3401 / 9.1.1.1 MIL-DTL 83513 EIA-364-21 IEC 60512 test 3a methB MIL-STD 202 test meth 302
Low level contact resistance	6 mΩ	ESCC 3401 / 9.1.1.3 MIL-DTL 83513 EIA 364-06 MIL-STD 202 Meth 307
Rated current contact resistance	5 mΩ	
Overload test	Temperature < 100°C	ESCC 3401 / 9.26 A current of 3 Amp for AWG 26 and AWG 28 are passed through all contacts of mated connectors for 30s. This was followed by a period of 90 s with no current flowing. This constitutes 1 cycle. The cycle has been repeated 5 times (10 minutes in total).
Shielding effectiveness	>60dB attenuation from 1 to 500 MHz	IEC-60512-23-3
Shell to shell continuity	Composite version: < 2mΩ	EIA 364-83 EN2591-205
	Aluminum version: < 2mΩ	

Climatic		
Description	Requirement	Test method
Dry heat	At 125 °C : insulation resistance > 5,000MΩ at 500 VDC	ESCC 3401 / 9.13.2 IEC 68-2-2 test Ba 2 hours at 175°C with sudden change of temperature.
Climatic sequence: Dry heat / Damp heat / Cold test / Low air pressure / Damp heat	No breakdown or flashover during low air pressure test, mated and unmated at 150VAC Insulation resistance > 100 MΩ at 500VDC just after Damp heat 2 test	ESCC 3401 / 9.13 Dry heat: IEC 60068-2-2 test Ba (2 hours at 175°C with sudden change of temperature) Damp heat: IEC 60068-2-30 test Db severity b Cold test: IEC 60068-2-1 test Aa (2 hours at -65°C with sudden change of temperature) Low Air Pressure: IEC 60068-2-13 test M (33,000m = 108,000 ft)
Storage temperature range	-65°C to +125°C	ESCC 3401 / 9.21 IEC 512-6 test 11i for 1.000 h at +125°C
Soldering temperature	+260°C	ESCC 3401 / 9.31 EIA-364-56 Procedure 3 Test Condition B
Salt spray (corrosion)	No corrosion on the interfaces or mating surfaces after 2000 hours for composite shell and 48 hours for aluminum shell.	ESCC 3401 / 9.22 IEC 60068-2-11 test Ka



Technical features

Detailed performances

Mechanical		
Description	Requirement	Test Method (ESCC and equivalent if existing)
Endurance / Durability	500 mating/unmating operations Connectors shall meet contact resistance, insulation resistance, DWV, and mating and unmating force.	ESCC 3401 / 9.18 MIL-DTL 83513 8 cycles/minute maximum
Insert retention in shell	34,4 N/cm ² (50 psi)	ESCC 3401 / 9.23 MIL-DTL 83513
Tensile test	F>60N for #24 cable, F>45N for #26 cable and F>30N for #28 cable	ECSS-Q70-26A SAE AS-39029
Vibration	No discontinuity > 1µs, no cracking, breaking or loosening of parts, plug shall not become disengaged from receptacle. Connectors shall meet electrical requirements after vibration test.	Random: 20g (tested at 44g)
		Sine: 20g
Shock and bump	No discontinuity > 1µs, no cracking, breaking or loosening of parts, plug shall not become disengaged from receptacle. Connectors shall meet electrical requirements after shock and bump tests.	Shock: 50g for 11ms
		Bump: 390 m/s ²
Contact insertion/removal endurance	Contact insertion and withdrawal forces < 13.5 N Contact retention in insert > 15 N	ESCC 3401 / 9.11 IEC 60068-2-35, test Fda (8h x 3axis, f1 = 20Hz, f2 = 2000Hz)
Probe damage	Separation force mini > 0.14 N	ESCC 3401 / 9.11 IEC 60512-4 test 6d (30min x 3axis, 10Hz-2000Hz)
Contact retention in insert	Displacement < 0,3 mm (.012 in) at >15 N	ESCC 3401 / 9.12 IEC 60512-4 6c (3 shocks x3 axes x2 directions = 18 shocks)
Max engagement force	1,66 N	ESCC 3401 / 9.12 IEC 60512-4 6b (4,000 ± 10 bump x3axis x 2directions = 24,000 bump)
Min separation force	0,14 N	ESCC 3401 / 9.12
Contact insertion/removal endurance	Contact insertion and withdrawal forces < 13.5 N Contact retention in insert > 15 N	9 cycles insertion/removal
Probe damage	Separation force mini > 0.14 N	ESCC 3401 / 9.30 IEC 60512-8 test 16A bending moment = 0.9 Ncm
Contact retention in insert	Displacement < 0,3 mm (.012 in) at >15 N	ESCC 3401 / 9.17
Max engagement force	1,66 N	ESCC 3401 / 9.28
Min separation force	0,14 N	

Space requirements		
Description	Requirement	Test method
Residual magnetism	< 200 gamma	ESCC 3401 / 9.5
Magnetic permeability	< 2 mu	EIA 364-54
Permanence of marking	No deterioration after 3 immersions of 1mn in solvent with 10 brushings after each immersion	ESCC basic specification 24800
Traceability	Mandatory	ESCC basic specification 20101
Thermal vacuum outgassing	1% total mass loss max. 1% recovered mass loss max 0.1% collected volatile condensable materials	ESCC-Q-ST-70-02C SP-R-0022A ASTM E595



Technical features

Weight

Composite shells are up to 36% lighter than aluminum.

Shell max weight* in g (oz)				
	Composite version		Aluminum version	
	Male	Female	Male	Female
A	1.05 (0.037)	1 (0.035)	1.35 (0.048)	1.45 (0.051)
B	1.35 (0.048)	1.25 (0.044)	1.75 (0.062)	1.8 (0.063)
C	1.6 (0.056)	1.45 (0.051)	2.15 (0.076)	2.2 (0.078)
D	1.8 (0.063)	1.65 (0.058)	2.35 (0.083)	2.4 (0.085)
E	2.1 (0.074)	1.88 (0.066)	2.7 (0.095)	2.69 (0.095)
F	2.35 (0.083)	2.1 (0.074)	2.95 (0.104)	2.9 (0.103)
G	2.5 (0.088)	2.2 (0.078)	3.15 (0.111)	3.05 (0.108)
H	3.44 (0.121)	2.95 (0.104)	4.2 (0.148)	4.1 (0.145)
J	6.1 (0.215)	4.75 (0.168)	7.3 (0.257)	6.45 (0.228)

* without contact

Contact max weight in g (oz)		
Contacts	Male	Female
Crimp contacts	0.04 (0.0014)	0.06 (0.0021)
Straight PC tails (spills) contacts	0.08 (0.0028)	
90° PC tails (spills) contacts for shell size A to F*	0.09 (0.0032)	
90° PC tails (spills) contacts for shell size G and H*	0.097 (0.0034)	
90° PC tails (spills) contacts for shell size J*	0.11 (0.0039)	

* average weight

w forces

Shell sizes									
	A	B	C	D	E	F	G	H	J
Mating force max (N)	11.9	18.7	22.1	28.9	35.7	42.5	56.1	86.7	178.8



Qualified following ESA procedure

Described in ESA/ESCC Generic Specification 3401

As described in ESCC Basic Specification 20100 microComp® will be re-qualified every 2 years.
All para. refer to ESCC Generic Specification 3401

Chart IV Qualification Tests

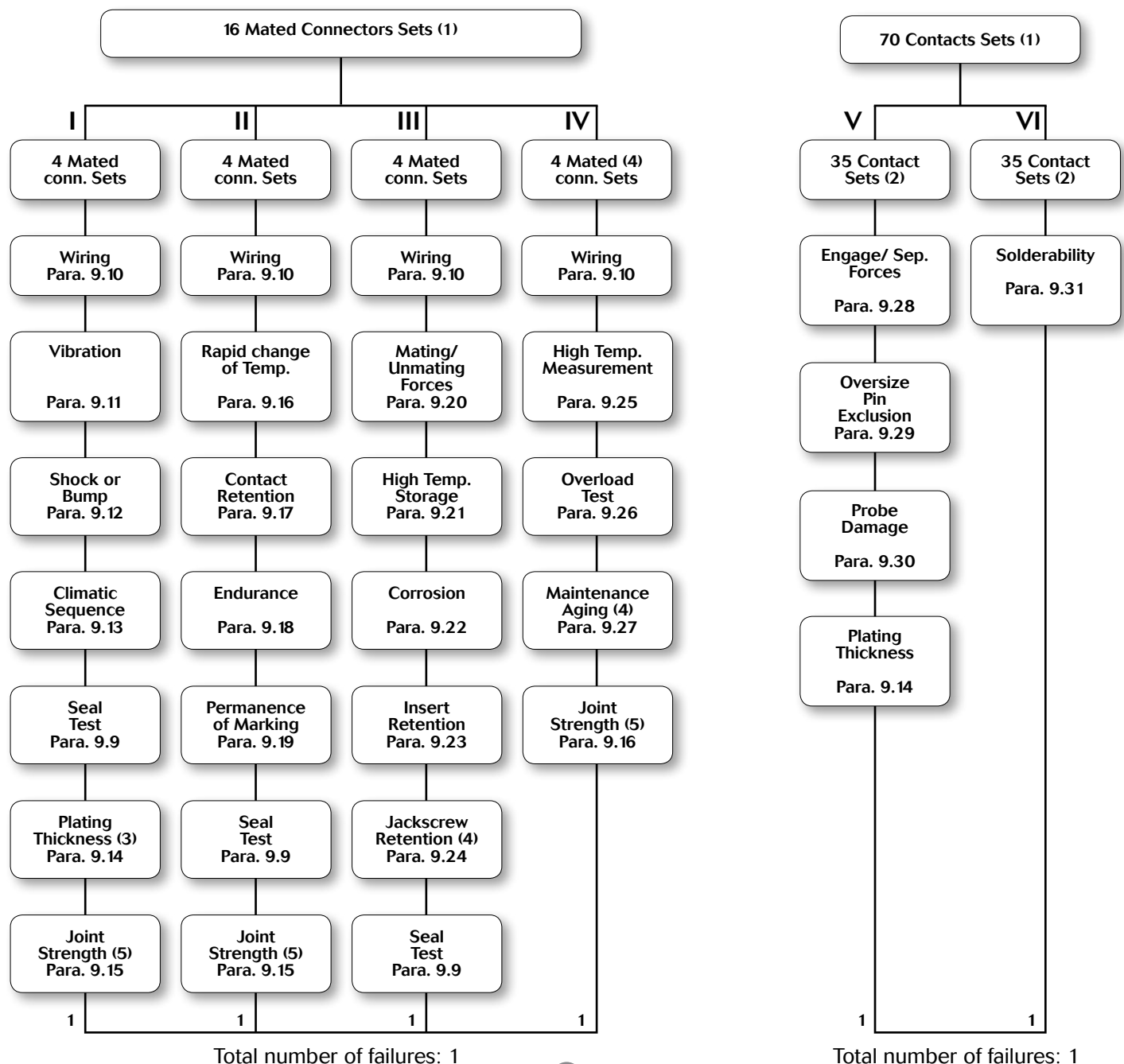



Quality levels and controls

Difference between "ESA" and "Space Grade" *microComp*®
 The "ESA" version complies with ESA specification 3401-081 to -084

	ESA <i>microComp</i> ®	Space Grade <i>microComp</i> ®
P/N	ESA P/N (3401...)	Souriau P/N (8MCG... and 8MCAG...)
Application	Flight Models	Test Models
Product	Same components Same materials	
	Sealed version non available	Sealed version available
Production	Same manufacturing process	
Traceability	ESA traceability Delivered with a certificate of conformity	Basic traceability No certificate

In-process control: comparison between ESA, Space Grade *microComp*® and NASA (GSFC) screening requirements

		ESA <i>microComp</i> ®	Space Grade <i>microComp</i> ®	NASA micro-D (MIL-DTL-835 13) screening requirements (EEE-INST-002, table 2C)*		
				Level 1	Level 2	Level 3
Shell after plating	Visual:	100%		100%	100%	100%
	Microscope x8 on functional areas:	100%		N/A	N/A	N/A
	Mechanical dimensions:	Sampling		Sampling	Sampling	N/A
Insulator (removable crimp contact version)	Visual:	100%		100%	100%	100%
	Microscope x8 on functional areas:	100%		N/A	N/A	N/A
	Clips presency:	100%		N/A	N/A	N/A
	Contact retention:	Sampling		N/A	N/A	N/A
	Dielectric Wistanding Voltage:	100%		100%	Sampling	N/A
	Insulation Resistance	100%		Sampling	Sampling	N/A
	Mechanical dimensions:	Sampling		Sampling	Sampling	N/A
Crimp contacts	Visual:	100%		100%	100%	100%
	Microscope x8 on functional areas:	100%		N/A	N/A	N/A
	Socket contacts capability:	100%		N/A	N/A	N/A
	Mechanical dimensions:	Sampling		Sampling	Sampling	N/A
Insulator with contacts (PC tails/spills version)	Visual:	100%		100%	100%	100%
	Microscope x8 on functional areas:	100%		N/A	N/A	N/A
	Dielectric Wistanding Voltage:	100%		100%	Sampling	N/A
	Insulation Resistance:	100%		Sampling	Sampling	N/A
	Mechanical dimensions:	Sampling		Sampling	Sampling	N/A
Accessories	Visual:	100%		100%	100%	100%
	Microscope x8 on functional areas:	100%		N/A	N/A	N/A
	Mechanical dimensions:	Sampling		N/A	N/A	N/A

* For comparison only



Lot Acceptance Tests

Two levels are proposed according to ESCC specification 3401 Chart V.

Ordering information: consult us.

Lot acceptance level shall be specified in the purchase order.

Chart V

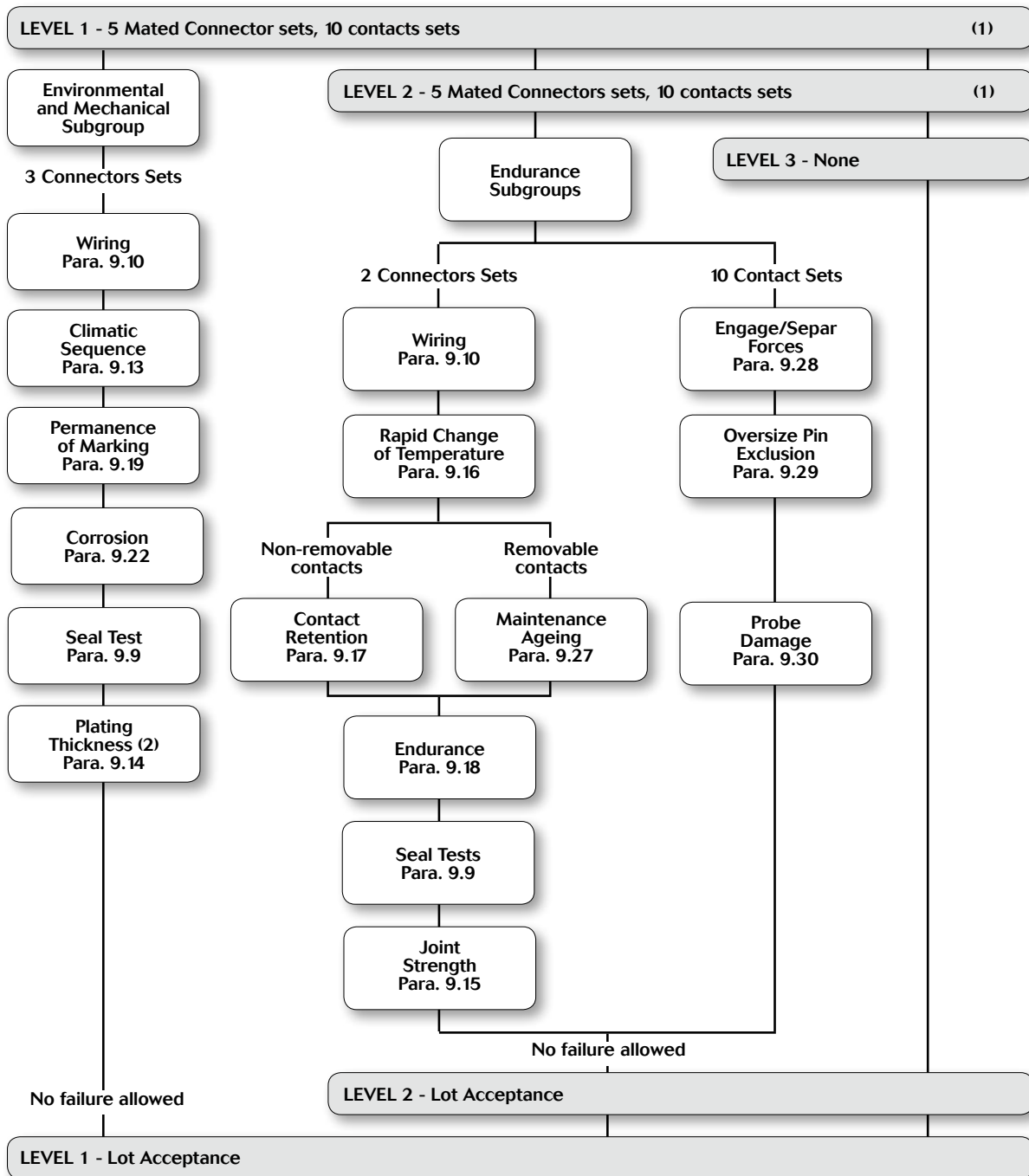

Notes: 1. For distribution within the sample see Para 8.2.2. - 2. Hermetic connectors only. - All Para. Refer to ESA/SCC Generic Specification 3401



Contact layouts



Shell size	Number of contacts	Front view of male insert
A	7	
B*	11	
C	13	
D*	17	
E*	21	
F	25	
G*	33	
H	51	
J	104	

* Consult us for availability.

Contact size: #26
Contact pitch: 2.0 mm

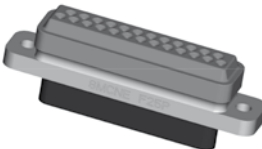

Contact types

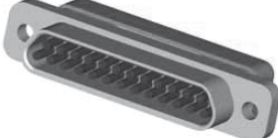
Crimp	Unsealed	Sealed
	Male (-P011 / -PNMBFO with contacts)	Male with grommet (-E-P011)
		
	Female (-S011 / -SNMBFO with contacts)	Female with grommet and interfacial seal (-E-S011)
		

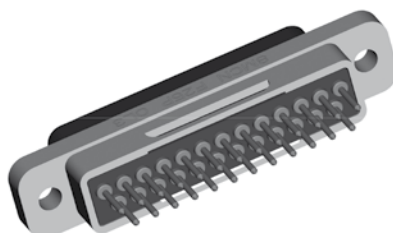
Straight PCB	Straight PCB	
	Male (-POL3 / -PNMBOL3)	
		

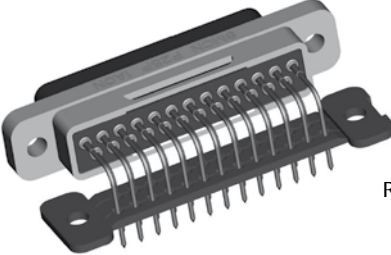
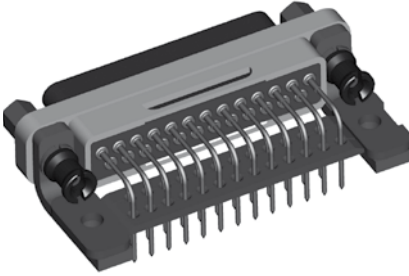
90° bent PCB	Male without fixing accessories	Male with standard jackposts
	(-P1AON / -PNMB1AON)	(-P1A7N / -PNMB1A7N)
	 Rear view	 Rear view



Ordering information

Space Grade part-numbering

Space Grade series - PCB versions		8MC	G		F25	P	1A7N
Shell material:	None: composite A: aluminum						
Version:	G: Space grade (electroless Gold finish) <i>For ESA P/N, consult ESA series part-numbering system</i>						
Environment:	None: no sealing						
Shell size & contact layout:	A7: 7 contacts B11: 11 contacts* C13: 13 contacts D17: 17 contacts* E21: 21 contacts* F25: 25 contacts G33: 33 contacts* H51: 51 contacts J104: 104 contacts						
Contact type:	P: Pin contacts for male connector <i>For S socket contacts: consult us for availability</i>						
Termination code:	OL3: Straight spills (PC tails) contacts 1AON: 90° spills (PC tails), without bracket, with removable drilled bar, 2.54mm pitch between rows 1A7N: 90° spills (PC tails), 2.54mm pitch between rows, with bracket, removable drilled bar and jackpost						

*Consult us for availability
Jackscrews kits are never included

Space Grade series - Crimp versions		8MC	G	E	F25	S	011
Shell material:	None: composite A: aluminum						
Version:	G: Space grade (electroless Gold finish)						
Environment:	E: sealed version <i>With P011, P011B or PL termination: grommet</i> <i>With S011, S011B or SL termination: grommet + interfacial seal</i> T: sealed version, interfacial seal only <i>The interfacial seal is always on the female connector (-S- contact type)</i> None: no sealing						
Shell size & contact layout:	A7: 7 contacts B11: 11 contacts* C13: 13 contacts D17: 17 contacts* E21: 21 contacts* F25: 25 contacts G33: 33 contacts* H51: 51 contacts J104: 104 contacts						
Contact type:	P: Pin contacts for male connector S: Socket contacts for female connector						
Termination code:	011: Crimp contacts for wire AWG 26 & 28 011B: Crimp contacts for wire AWG 24 & 26* L: delivered without contact						

*Consult us for availability
Jackscrews kits are never included
Insertion/extraction tool SMCIET is always included with -S011, -S011B, -P011B and -P011 versions, but not with -L versions.
Termination codes -011, -011B and -L are not marked on the connector (only for order)

For contact Part Number, see "Crimp Removable Contacts" chapter.



Ordering information

ESA part-numbering

ESA series - PCB connectors		3 401 081	01	B	F25	P	NMB	1A7N
Shell material:	01: composite 02: aluminum							
Testing level:	B							
Shell size & contact layout:	A7 : 7 contacts B11 : 11 contacts* C13 : 13 contacts D17 : 17 contacts* E21 : 21 contacts* F25 : 25 contacts G33 : 33 contacts* H51 : 51 contacts J104 : 104 contacts							
Contact type:	P: Pin contacts for male connector							
Magnetism level:	NMB: Magnetism level < 200 gamma (only for shell material 01)							
Termination code:	OL3: Straight spills (PC tails) contacts 1AON: 90° spills (PC tails), without bracket, with drilled bar, 2.54mm pitch between rows 1A7N: 90° spills (PC tails), 2.54mm pitch between rows, with bracket, drilled bar and jackpost							

*Consult us for availability

Jackscrews kits are never included

ESA series - Crimp connectors		3 401 082	01	B	J104	S	NMB	FO
Shell material:	01: composite 02: aluminum							
Testing level:	B							
Shell size & contact layout:	A7 : 7 contacts B11 : 11 contacts* C13 : 13 contacts D17 : 17 contacts* E21 : 21 contacts* F25 : 25 contacts G33 : 33 contacts* H51 : 51 contacts J104 : 104 contacts							
Contact type:	P: Pin contacts for male connector S: Socket contacts for female connector							
Magnetism level:	NMB: Magnetism level < 200 gamma (only for shell material 01)							
Termination code:	FO: delivered without contact None : delivered with contacts for AWG 26/28							

*Consult us for availability

Jackscrews kits are never included

Termination code FO is not marked on the connector (only for order)

For contact Part Number, see "Crimp Removable Contacts" chapter.



Crimp removable contacts

ESCC 3401/083 defines the design, dimensions and performances of contacts #26 used in *microComp*®. These contacts are made of copper and gold plated. They have been designed for high electrical and mechanical performance – they withstand high shock and vibration. These contacts are crimped to wire using standard MIL spec crimp tool M22500/2-01 and a locator for #26 contacts.

Male contact (pin):

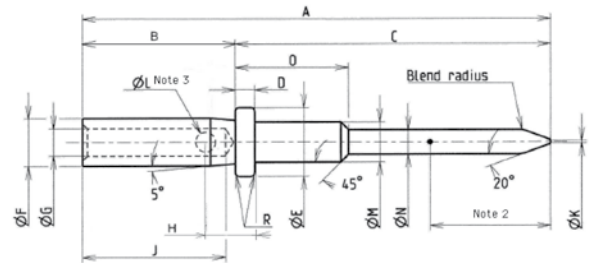

#26 male contacts part numbers:		
Wire size	AWG 24-26*	AWG 26-28
Space Grade P/N	8MC 00 103 NMB	8MC 00101 NMB
ESA P/N	3401083 03B	3401083 01B

Dimensions in mm (inch)																	
	A	B	C	D	ØE	ØF		ØG		H	J	ØK	ØL	ØM	ØN	O	R
						AWG 24/26*	AWG 26/28	AWG 24/26*	AWG 26/28								
Min. mm (inch)	-	3,10 (.122)	6 (.236)	0,35 (.014)	1,37 (.054)	1,00 (.039)	0,92 (.036)	0,73 (.029)	0,56 (.022)	1 (.039)	2,90 (.114)	-	0,40 (.016)	0,80 (.031)	0,50 (.019)	1,85 (.073)	0,04 (.002)
Max. mm (inch)	9,80 (.386)	3,25 (.128)	6,10 (.240)	0,41 (.016)	1,41 (.055)	1,08 (.043)	0,98 (.039)	0,76 (.030)	0,60 (.024)	1,10 (.043)	3,10 (.122)	0,15 (.006)	0,50 (.020)	0,82 (.032)	0,52 (.021)	1,91 (.075)	0,08 (.003)

*Consult us for availability

Female contact (socket):

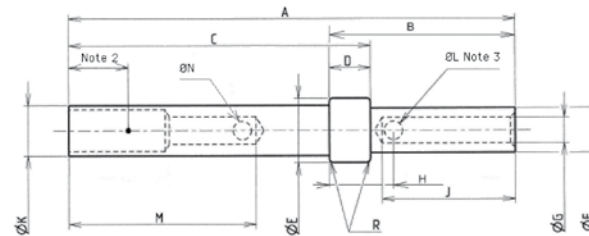

#26 female contacts part numbers:		
Wire size	AWG 24-26*	AWG 26-28
Space Grade P/N	8MC 00104 NMB	8MC 00102 NMB
ESA P/N	3401083 04B	3401083 02B

Dimensions in mm (inch)																
	A	B	C	D	ØE	ØF		ØG		H	J	ØK	ØL	M	ØN	R
						AWG 24/26*	AWG 26/28	AWG 24/26*	AWG 26/28							
Min. mm (inch)	-	4,05 (.159)	6,55 (.258)	0,85 (.033)	1,37 (.054)	1,00 (.039)	0,92 (.036)	0,73 (.029)	0,56 (.022)	1,40 (.055)	2,90 (.114)	1,05 (.041)	0,40 (.016)	4,10 (.161)	0,40 (.016)	0,04 (.002)
Max. mm (inch)	9,80 (.386)	4,15 (.163)	6,60 (.260)	0,91 (.036)	1,41 (.055)	1,08 (.043)	0,98 (.039)	0,76 (.030)	0,60 (.024)	1,51 (.059)	3,10 (.122)	0,15 (.006)	0,50 (.020)	0,82 (.032)	0,50 (.020)	0,08 (.003)

*Consult us for availability



Mating dimensions and contact position

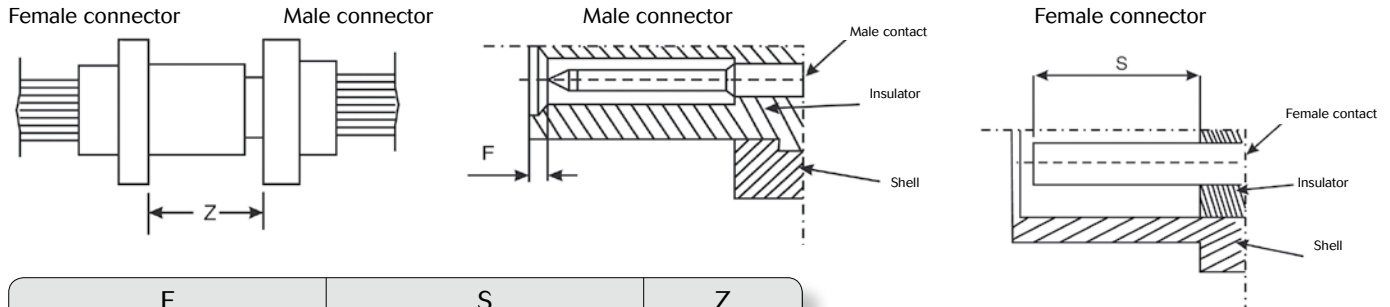

F		S		Z
Min	Max	Min	Max	Max
0,22 (.0087)	0,72 (.028)	4,15 (.163)	4,65 (.183)	5,21 (.205)

All dimensions in mm (inch)

Wiring instructions

Insertion and extraction tool:

P/N: SMCJET

M22500 crimp tool and specific locator:

Use standard M22520/2-01 crimp tool with the following locators:

	Male	Female
Locator P/N	8985-3093A	8985-3094A
AWG 24 - 26	Mark n°4	Mark n°4
AWG 28	Mark n°2	Mark n°2



Cable preparation and wire stripping

L = Length of wire stripping

Contact size	L min.	L max.
# 26 mm (inch)	2,91 (.114)	3,41 (.134)

Insertion of wire in contact barrel

When inserting the stripped wire into the contact barrel check that no strands are left outside and that the wire is visible through the wire inspection hole in the barrel

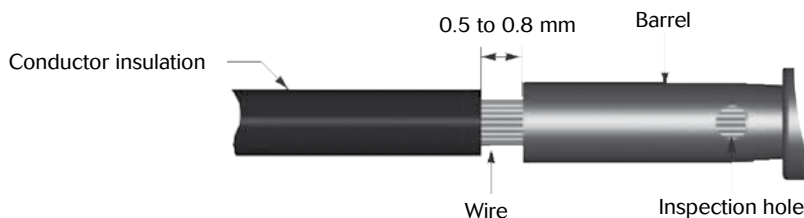



Wiring instructions

Contacts are inserted and extracted from the rear of the connector

Insertion of the contacts

1 - Engage the crimp cable / contact assembly into the longitudinal slot of the plastic tool SMCIET (yellow side). Slide the tool down the cable until the tip of the tool abuts the contact retention shoulder.

1-



2 - Introduce the contact into the required contact cavity in the insulator, pushing the tool axially, until the contact snaps into position in the clip.

2-

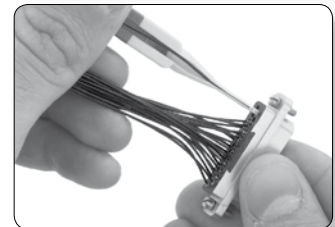

3 - Withdraw the tool (from rear). Check that the contact is firmly locked by pulling the wire gently. When the connector is fully loaded, check the position of the contact tips. They should all be in the same plane.

3-

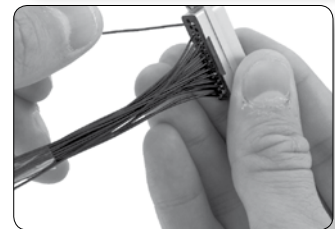

Extraction of the contacts

1 - Engage the appropriate cable into the longitudinal slot of the tool with the blue tip towards the connector.

1-

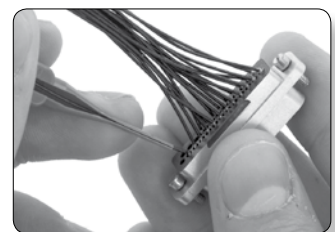

2 - Slide the tool down towards the contact. Insert the tool in the insulator until it abuts the contact shoulder.

2-

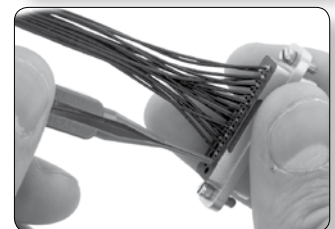

3 - Holding the tool-contact and cable assembly together, remove them simultaneously.

3-

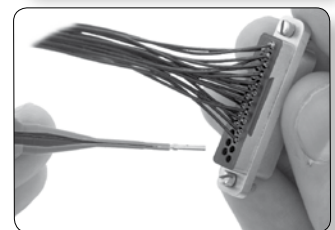

Please consult ESA [ECSS-Q-ST-70-26C](#) and NASA [STD 8739.4](#) recommendations for crimping



Dimensions

Female shell

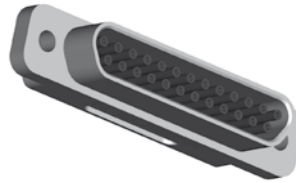
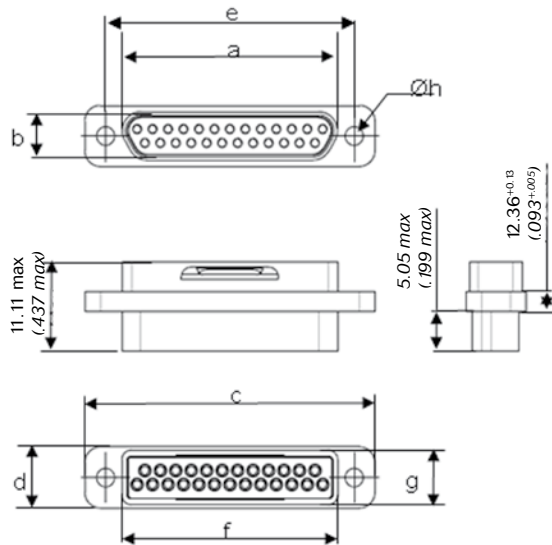

Optional Design Oblong Holes Shell Size H

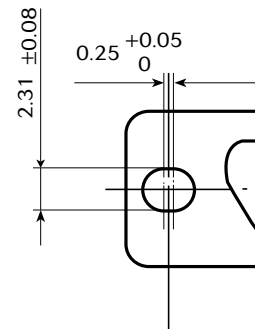

Sealed version (grommet and interfacial seal)

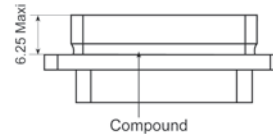
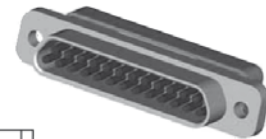
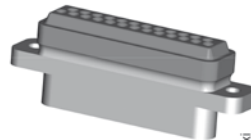

Shell Size	a	b	c		d		e		f		g	h
	Max	Max	min	Max	min	Max	min	Max	min	Max	Max	min
A	10,16 (.400)	6,38 (.251)	19,43 (.765)	19,94 (.785)	7,31 (.288)	7,82 (.307)	14,22 (.559)	14,48 (.570)	9,45 (.372)	10,16 (.400)	6,86 (.270)	2,26 (.089)
B	13,97 (.550)	6,38 (.251)	23,25 (.915)	23,75 (.935)	7,31 (.288)	7,82 (.307)	18,03 (.709)	18,29 (.720)	13,26 (.522)	13,97 (.550)	6,86 (.270)	2,26 (.089)
C	17,78 (.634)	6,38 (.251)	27,05 (1.065)	27,56 (1.085)	7,31 (.288)	7,82 (.307)	21,84 (.859)	22,10 (.870)	17,07 (.672)	17,78 (.700)	6,86 (.270)	2,26 (.089)
D	20,32 (.700)	6,38 (.251)	29,59 (1.165)	30,10 (1.185)	7,31 (.288)	7,82 (.307)	24,38 (.959)	24,64 (.970)	19,61 (.772)	20,32 (.800)	6,86 (.270)	2,26 (.089)
E	24,13 (.950)	6,38 (.251)	33,41 (1.315)	33,91 (1.335)	7,31 (.288)	7,82 (.307)	28,19 (1.149)	28,45 (1.120)	23,42 (.992)	24,13 (.950)	6,86 (.270)	2,26 (.089)
F	27,94 (1.100)	6,38 (.251)	37,21 (1.465)	37,72 (1.485)	7,31 (.288)	7,82 (.307)	32,00 (1.259)	32,26 (1.270)	27,23 (1.072)	27,94 (1.100)	6,86 (.270)	2,26 (.089)
G	26,67 (1.050)	7,47 (.294)	35,95 (1.415)	36,45 (1.435)	8,42 (.331)	8,92 (.351)	30,73 (1.229)	30,99 (1.220)	25,96 (1.022)	26,67 (1.050)	6,86 (.270)	2,26 (.289)
H	38,65 (1.521)	7,47 (.294)	48,05 (1.891)	48,55 (1.911)	8,42 (.331)	8,92 (.351)	43,23 (1.702)	43,49 (1.712)	38,40 (1.512)	38,65 (1.522)	7,87 (.310)	2,26 (.089)
J	46,80 (1.842)	10,94 (.431)	62,25 (2.451)	62,75 (2.470)	12,00 (.472)	12,50 (.492)	54,72 (2.154)	54,98 (1.377)	47,40 (1.866)	47,65 (1.876)	11,25 (.443)	3,70 (.146)

All dimensions in mm (inches)





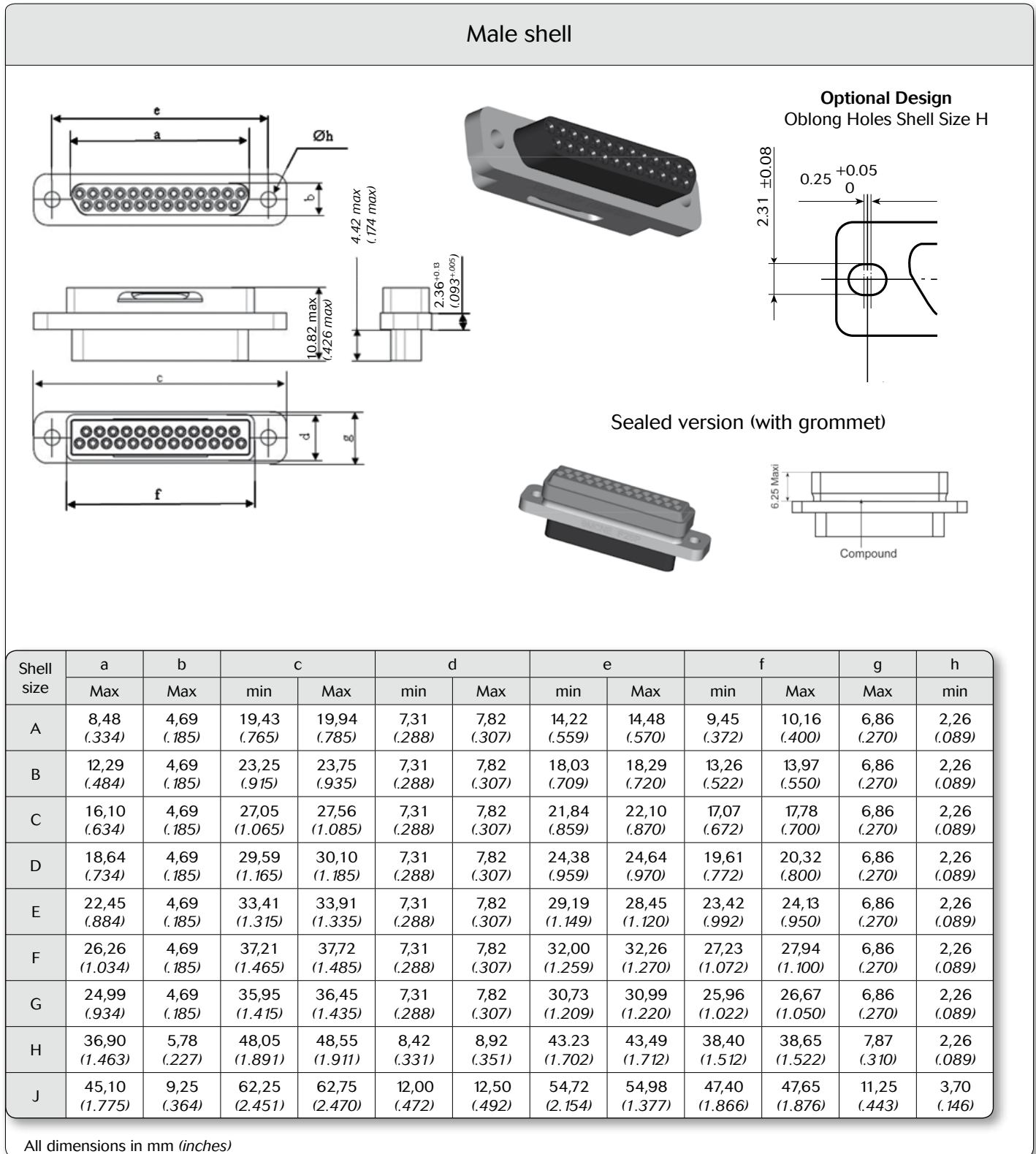

Dimensions



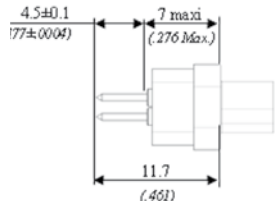

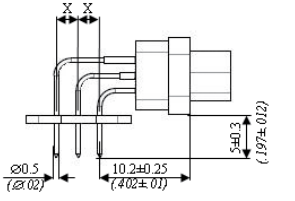
Dimensions

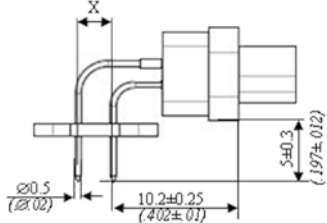
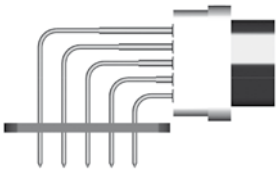
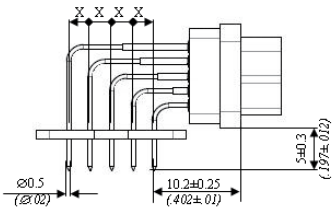
PCB versions – male connectors P1AON	
 <p>Straight - All shell sizes</p>	 <p> 4.5 ± 0.1 $(.177 \pm .004)$ 7 maxi $(.276 \text{ Maxi})$ 11.7 $(.461)$ </p>
 <p>90° - Shell sizes G and H</p>	 <p> X X 5 ± 0.3 $(.197 \pm .012)$ 10.2 ± 0.25 $(.402 \pm .01)$ $\varnothing 0.5$ $(.02)$ </p>
 <p>90° - shell sizes A to F</p>	 <p> X 5 ± 0.3 $(.197 \pm .012)$ 10.2 ± 0.25 $(.402 \pm .01)$ $\varnothing 0.5$ $(.02)$ </p>
 <p>90° - Shell size J</p>	 <p> X X X X 5 ± 0.3 $(.197 \pm .012)$ 10.2 ± 0.25 $(.402 \pm .01)$ $\varnothing 0.5$ $(.02)$ </p>

X=2.54 (.1)

All dimensions in mm (inches)

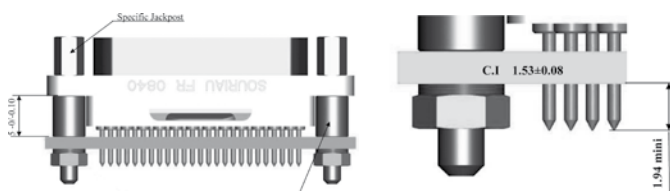
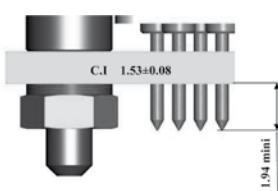
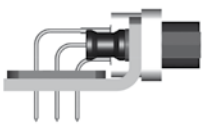
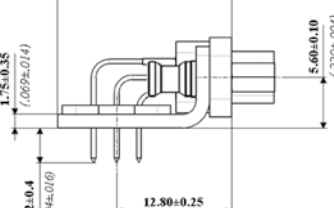
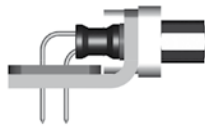
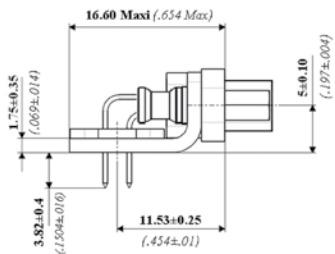
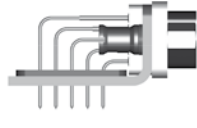
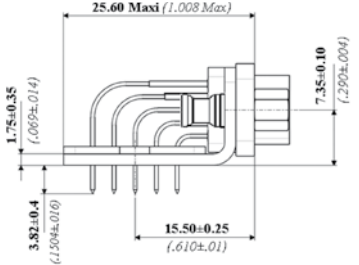
PCB versions – male connectors with mounting accessories P1A7N	
 <p>Straight - All shell sizes</p>	 <p> 1.94 mini $C.1 \ 1.53 \pm 0.08$ 5.60 ± 0.10 $(.220 \pm .004)$ 12.80 ± 0.25 1.75 ± 0.35 $(.069 \pm .014)$ 1.4 $(.05)$ </p>
 <p>90° - Shell sizes G and H</p>	 <p> 5.60 ± 0.10 $(.220 \pm .004)$ 12.80 ± 0.25 1.75 ± 0.35 $(.069 \pm .014)$ 1.4 $(.05)$ </p>
 <p>90° - shell sizes A to F</p>	 <p> 16.60 Maxi $(.654 \text{ Maxi})$ 5 ± 0.10 $(.197 \pm .004)$ 11.53 ± 0.25 $(.454 \pm .01)$ 3.82 ± 0.4 $(.150 \pm .016)$ 1.75 ± 0.35 $(.069 \pm .014)$ </p>
 <p>90° - Shell size J</p>	 <p> 25.60 Maxi (1.008 Maxi) 7.35 ± 0.10 $(.290 \pm .004)$ 15.50 ± 0.25 $(.610 \pm .01)$ 3.82 ± 0.4 $(.150 \pm .016)$ 1.75 ± 0.35 $(.069 \pm .014)$ </p>

X=2.54 (.1)

All dimensions in mm (inches)



Mounting operations and hardware

Double panel mounting dimensions

For hardware dimensions consult the mounting hardware section.

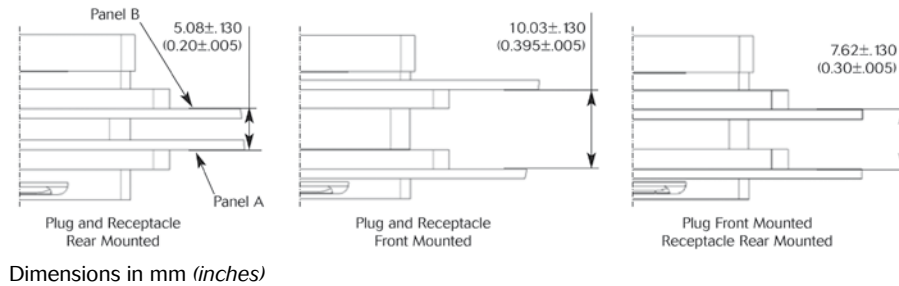

Option 1: Front mounting on panel

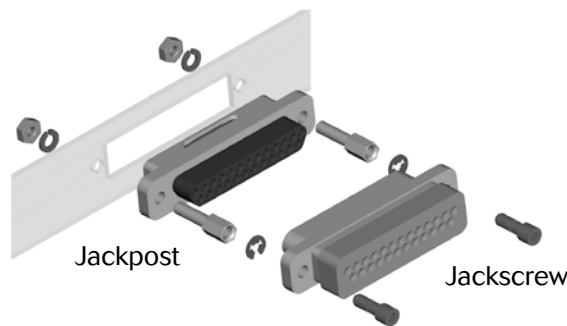

Mounting hardware for front mounting on panel:

Space Grade (SOURIAU P/N)			
Individual packaging (one package for one mated pair)			
Type		P/N	Description
Standard Jackpost (not for rear panel mounting)	Size A-H	8MCJP507NM	Jackpost Kit for <i>microComp</i> ® shell size A to H (2 jackposts + 2 washers + 2 nuts). Front panel or cable-to-cable mounting.
	Size J	8MCJP517NM	Jackpost Kit for <i>microComp</i> ® shell size J (2 jackposts + 2 washers + 2 nuts). Front panel or cable-to-cable mounting.

Space Grade (SOURIAU P/N)			
Packaging per 50 kits (one package for 50 mated pair)			
Type		P/N	Description
Standard Jackpost (not for rear panel mounting)	Size A-H	8MCJP507NM50	Jackpost Kit for <i>microComp</i> ® shell size A to H (100 jackposts + 100 washers + 100 nuts). Front panel or cable-to-cable mounting.
	Size J	8MCJP517NM50	Jackpost Kit for <i>microComp</i> ® shell size J (100 jackposts + 100 washers + 100 nuts). Front panel or cable-to-cable mounting.



Option 1: Front mounting on panel

ESA P/N			
Individual packaging (two packages for one mated pair)			
Type		P/N	Description
Standard Jackpost (not for rear panel mounting)	Size A-H	3401084 03	Jackpost Kit for <i>microComp</i> ® shell size A to H (1 jackpost + 1 washer + 1 nut). Front panel or cable-to-cable mounting.
	Size J	3401084 06	Jackpost Kit for <i>microComp</i> ® shell size J (1 jackpost + 1 washer + 1 nut). Front panel or cable-to-cable mounting.

Option 2: Rear mounting on panel

With additional mounting on PCB: combined Option 2 and Option 3

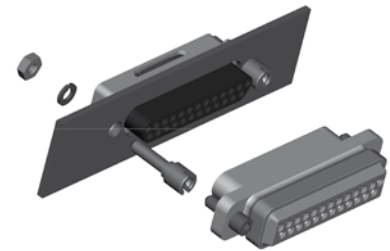

Mounting hardware for rear mounting on panel
for panel thickness from 0.8 mm to 3.2 mm.

Space Grade (SOURIAU P/N)				
Individual packaging (one package for one mated pair)				
Type		P/N	Panel	Description
Jackpost for rear panel mounting	Size A-H	8MCJP008NM	0,8 mm (.031 in)	Jackpost Kit for <i>microComp</i> ® shell size A to H (2 jackposts + 2 washers + 2 nuts).
		8MCJP012NM	1,2 mm (.047 in)	Jackpost Kit for <i>microComp</i> ® shell size A to H (2 jackposts + 2 washers + 2 nuts).
		8MCJP016NM	1,6 mm (.063 in)	Jackpost Kit for <i>microComp</i> ® shell size A to H (2 jackposts + 2 washers + 2 nuts).
		8MCJP024NM	2,4 mm (.094 in)	Jackpost Kit for <i>microComp</i> ® shell size A to H (2 jackposts + 2 washers + 2 nuts).
		8MCJP032NM	3,2 mm (.126 in)	Jackpost Kit for <i>microComp</i> ® shell size A to H (2 jackposts + 2 washers + 2 nuts).
	Size J	8MCJP508NM	0,8 mm (.031 in)	Jackpost Kit for <i>microComp</i> ® shell size J (2 jackposts + 2 washers + 2 nuts).
		8MCJP512NM	1,2 mm (.047 in)	Jackpost Kit for <i>microComp</i> ® shell size J (2 jackposts + 2 washers + 2 nuts).
		8MCJP516NM	1,6 mm (.063 in)	Jackpost Kit for <i>microComp</i> ® shell size J (2 jackposts + 2 washers + 2 nuts).
		8MCJP524NM	2,4 mm (.094 in)	Jackpost Kit for <i>microComp</i> ® shell size J (2 jackposts + 2 washers + 2 nuts).
		8MCJP532NM	3,2 mm (.126 in)	Jackpost Kit for <i>microComp</i> ® shell size J (2 jackposts + 2 washers + 2 nuts).



Mounting operations and hardware

Option 2: Rear mounting on panel

With additional mounting on PCB: combined Option 2 and Option 3

Space Grade (SOURIAU P/N)				
Packaging per 50 kits (one package for 50 mated pairs)				
Type	P/N	Panel	Description	
Jackpost for rear panel mounting	Size A-H	8MCJP008NM50	0,8 mm (.031 in)	Jackpost Kit for <i>microComp</i> ® shell size A to H (100 jackposts + 100 washers + 100 nuts).
		8MCJP012NM50	1,2 mm (.047 in)	Jackpost Kit for <i>microComp</i> ® shell size A to H (100 jackposts + 100 washers + 100 nuts).
		8MCJP016NM50	1,6 mm (.063 in)	Jackpost Kit for <i>microComp</i> ® shell size A to H (100 jackposts + 100 washers + 100 nuts).
		8MCJP024NM50	2,4 mm (.094 in)	Jackpost Kit for <i>microComp</i> ® shell size A to H (100 jackposts + 100 washers + 100 nuts).
		8MCJP032NM50	3,2 mm (.126 in)	Jackpost Kit for <i>microComp</i> ® shell size A to H (100 jackposts + 100 washers + 100 nuts).
	Size J	8MCJP508NM50	0,8 mm (.031 in)	Jackpost Kit for <i>microComp</i> ® shell size J (100 jackposts + 100 washers + 100 nuts).
		8MCJP512NM50	1,2 mm (.047 in)	Jackpost Kit for <i>microComp</i> ® shell size J (100 jackposts + 100 washers + 100 nuts).
		8MCJP516NM50	1,6 mm (.063 in)	Jackpost Kit for <i>microComp</i> ® shell size J (100 jackposts + 100 washers + 100 nuts).
		8MCJP524NM50	2,4 mm (.094 in)	Jackpost Kit for <i>microComp</i> ® shell size J (100 jackposts + 100 washers + 100 nuts).
		8MCJP532NM50	3,2 mm (.126 in)	Jackpost Kit for <i>microComp</i> ® shell size J (100 jackposts + 100 washers + 100 nuts).

Option 3: Mounting on PCB with 90° bent contacts

Solder the connector contacts to the PCB
Screw the connector to the PCB

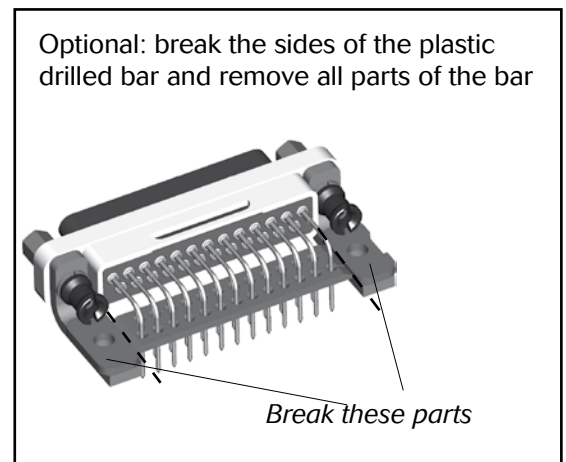
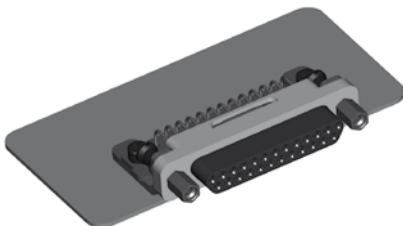



With additional rear mounting on panel: combined Option 2 and Option 3.

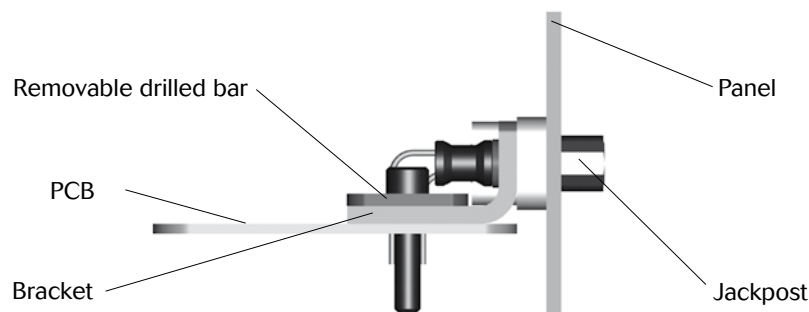

Mounting hardware for mounting on PCB with 90° bent contacts

Space Grade (SOURIAU P/N)			
Individual packaging (one package for one mated pair)			
Type		P/N	Description
Standard Jackpost (not for rear panel mounting)	Size A-H	8MCJP507NM	Jackpost Kit for <i>microComp</i> ® shell size A to H (2 jackposts + 2 washers + 2 nuts). Front panel or cable-to-cable mounting.
	Size J	8MCJP517NM	Jackpost Kit for <i>microComp</i> ® shell size J (2 jackposts + 2 washers + 2 nuts). Front panel or cable-to-cable mounting.
Brackets: to fix the receptacle on the PCB	Size A-F	8MCBKAFNM	Bracket kit for shell size A to F (2 brackets). Not for sealed version.
	Size G-H	8MCBKGHNM	Bracket kit for shell size G and H (2 brackets). Not for sealed version.
	Size J	8MCBKJNM	Bracket kit for shell size J (2 brackets). Not for sealed version.

Space Grade (SOURIAU P/N)			
Packaging per 50 kits (one package for 50 mated pairs)			
Type		P/N	Description
Standard Jackpost (not for rear panel mounting)	Size A-H	8MCJP507NM50	Jackpost Kit for <i>microComp</i> ® shell size A to H (100 jackposts + 100 washers + 100 nuts). Front panel or cable-to-cable mounting.
	Size J	8MCJP517NM50	Jackpost Kit for <i>microComp</i> ® shell size J (100 jackposts + 100 washers + 100 nuts). Front panel or cable-to-cable mounting.
Brackets: to fix the receptacle on the PCB	Size A-F	8MCBKAFNM50	Bracket kit for shell size A to F (100 brackets). Not for sealed version.
	Size G-H	8MCBKGHNM50	Bracket kit for shell size G and H (100 brackets). Not for sealed version.
	Size J	8MCBKJNM50	Bracket kit for shell size J (100 brackets). Not for sealed version.

ESA P/N			
Individual packaging (two packages for one mated pair)			
Type		P/N	Description
Standard Jackpost (not for rear panel mounting)	Size A-H	3401084 03B	Jackpost Kit for <i>microComp</i> ® shell size A to H (1 jackpost + 1 washer + 1 nut). Front panel or cable-to-cable mounting.
	Size J	3401084 06B	Jackpost Kit for <i>microComp</i> ® shell size J (1 jackpost + 1 washer + 1 nut). Front panel or cable-to-cable mounting.



Mounting operations and hardware

Option 4: Mounting on PCB with straight PCB contacts

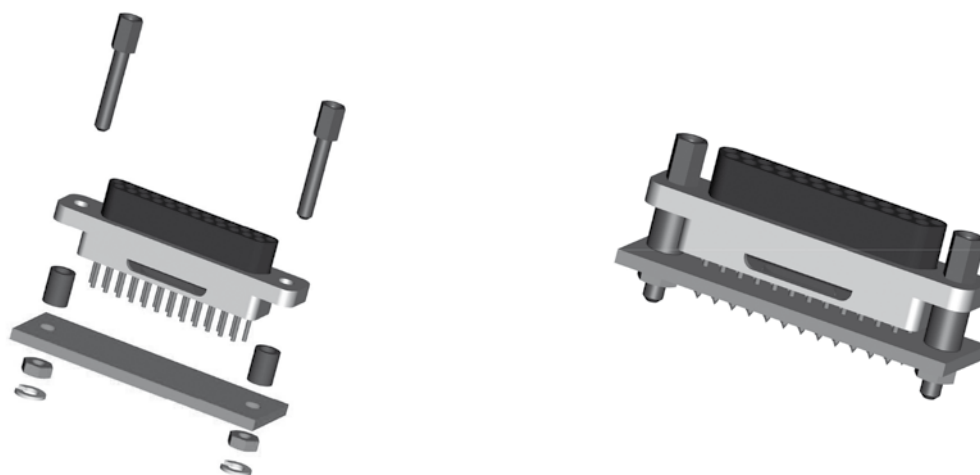

Mounting hardware for mounting on PCB with straight PCB contacts

Space Grade (SOURIAU P/N) Individual packaging (one package for one mated pair)			
Type		P/N	Description
Jackpost for PCB mounting (straight spills/ PC tails)	Size A-H	8MCJPS070NM	Jackpost kit for straight spills / PC tails <i>microComp</i> ® shell size A to H (2 jackposts + 2 spacers + 2 washers + 2 nuts). For mounting on PCB.
	Size J	8MCJPS170NM	Jackpost kit for straight spills / PC tails <i>microComp</i> ® shell size J (2 jackposts + 2 spacers + 2 washers + 2 nuts). For mounting on PCB.

Space Grade (SOURIAU P/N) Packaging per 50 kits (one package for 50 mated pairs)			
Type		P/N	Description
Jackpost for PCB mounting (straight spills/ PC tails)	Size A-H	8MCJPS070NM50	Jackpost kit for straight spills / PC tails version shell size A to H (100 jackposts + 100 washers + 100 nuts). For mounting on PCB.
	Size J	8MCJPS170NM50	Jackpost kit for straight spills / PC tails shell size J (100 jackposts + 100 washers + 100 nuts). For mounting on PCB.



Panel cut-out

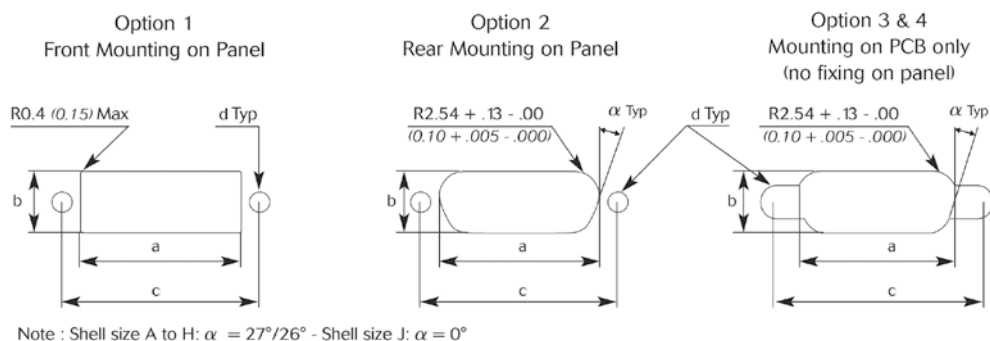

		Cut-out dimensions in mm (inch)			
Shell size	Mounting option	a +0.1 (+.004) -0.0 (.000)	b +0.1 (+.004) -0.0 (.000)	c +0.1 (+.004) -0.1 (-.004)	d +0.1 (+.004) -0.0 (.000)
A	1	10.36 (.408)	6.88 (.270)	14.35 (.565)	2.26 (.089)
	2	10.19 (.401)	6.40 (.252)	14.35 (.565)	2.26 (.089)
	3 & 4	10.19 (.401)	6.40 (.252)	14.35 (.565)	3.70 (.146)
B	1	14.17 (.558)	6.88 (.270)	18.56 (.731)	2.26 (.089)
	2	14.00 (.551)	6.40 (.252)	18.56 (.731)	2.26 (.089)
	3 & 4	14.00 (.551)	6.40 (.252)	18.56 (.731)	3.70 (.146)
C	1	17.98 (.708)	6.88 (.270)	21.97 (.865)	2.26 (.089)
	2	17.81 (.701)	6.40 (.252)	21.97 (.865)	2.26 (.089)
	3 & 4	17.81 (.701)	6.40 (.252)	21.97 (.865)	3.70 (.146)
D	1	20.52 (.808)	6.88 (.270)	24.51 (.965)	2.26 (.089)
	2	20.34 (.801)	6.40 (.252)	24.51 (.965)	2.26 (.089)
	3 & 4	20.34 (.801)	6.40 (.252)	24.51 (.965)	3.70 (.146)
E	1	24.33 (.958)	6.88 (.270)	28.32 (1.115)	2.26 (.089)
	2	24.16 (.951)	6.40 (.252)	28.32 (1.115)	2.26 (.089)
	3 & 4	24.16 (.951)	6.40 (.252)	28.32 (1.115)	3.70 (.146)
F	1	28.14 (1.108)	6.88 (.270)	32.13 (1.265)	2.26 (.089)
	2	27.97 (1.101)	6.40 (.252)	32.13 (1.265)	2.26 (.089)
	3 & 4	27.97 (1.101)	6.40 (.252)	32.13 (1.265)	3.70 (.146)
G	1	26.87 (1.058)	8.00 (.315)	30.86 (1.215)	2.26 (.089)
	2	26.70 (1.051)	7.49 (.295)	30.86 (1.215)	2.26 (.089)
	3 & 4	26.70 (1.051)	7.49 (.295)	30.86 (1.215)	3.70 (.146)
H	1	39.05 (1.537)	8.00 (.315)	43.36 (1.707)	2.26 (.089)
	2	38.65 (1.522)	7.49 (.295)	43.36 (1.707)	2.26 (.089)
	3 & 4	38.65 (1.522)	7.49 (.295)	43.36 (1.707)	3.70 (.146)
J	1	48.05 (1.892)	11.40 (.449)	54.85 (2.159)	3.20 (.126)
	2	46.80 (1.842)	11.10 (.437)	54.85 (2.159)	3.20 (.126)
	3 & 4	46.80 (1.842)	11.10 (.437)	54.85 (2.159)	5.60 (.220)

All dimensions in mm (inches)



PCB drilling

Shell size	Number of contacts	Drilling dimensions
A	7	
B	11	
C	13	
D	17	
E	21	

Shell size	Number of contacts	Drilling dimensions
F	25	
G	33	
H	51	
J	104	

	X	y
OL3	1.732 (.068)	3.464 (.136)
1AON	2.540 (.1)	5.08 (.2)

All dimensions in mm (inches)

Note: we suggest 0.89 (.035) Ø hole for contact termination positions on PCB (0.50 (.020) Ø spills).



Mounting hardware

Brackets for mounting on PCB with 90° bent contacts

Shell size	A to H		J	
Torque value	Min (Nm)	Max (Nm)	Min (Nm)	Max (Nm)
	0.44	0.48	0.6	0.66

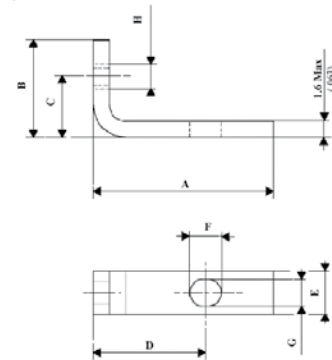

For shell size	P/N for individual packaging (one package for one mated pair: 2 brackets)	P/N for packaging per 50 (one package for 50 mated pair: 100 brackets)	A max	B max	C	D	E	F max	G	H
A to F	8MCBKAFNM	8MCBKAFNM50	14.10 (.555)	8.60 (.338)	5.0±0.10 (.197±.004)	9.17 ±0.10 (.361 ±.004)	4.0 ±0.10 (.158 ±.004)	3.15 (.124)	2.44 ±0.10 (.096 ±.004)	#20-56 UNC-2B
G and H	8MCBKGHNM	8MCBKGHNM50	16.90 (.665)	9.10 (.359)	5.6±0.10 (.220 ±.004)	10.44±0.10 (.411 ±.004)	4.0±0.10 (.158 ±.004)	3.15 (.124)	2.44 ±0.10 (.096 ±.004)	#20-56 UNC-2B
J	8MCBKJNM	8MCBKJNM50	23.10 (.909)	13.10 (.515)	7.35±0.10 (.290 ±.004)	13.13±0.10 (.516 ±.004)	6.50±0.10 (.256 ±.004)	4.20 (.165)	3.15 ±0.15 (.124 ±.006)	#20-56 UNC-2B

All dimensions in mm (inches)

Standard Jackpost

Shell size	A to H		J	
Torque Values	Min (Nm)	Max (Nm)	Min (Nm)	Max (Nm)
Jackpost male side	0.44	0.48	0.6	0.66
Jackpost female side	0.28	0.32	0.4	0.44
Nut	0.44	0.48	0.6	0.66

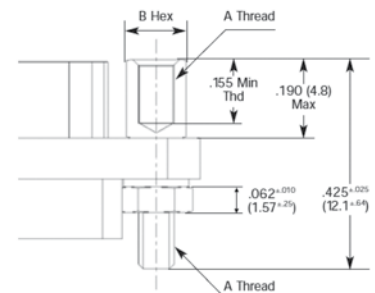
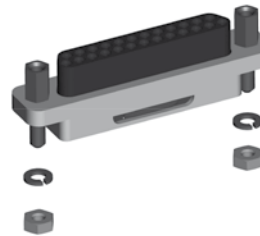



Mounting hardware

Standard Jackpost

For shell size	A to H	J
A thread size	#2-56 UNC	#4-40 UNC
B hex size in mm (<i>inch</i>)	3,18 (.125)	4,75 (.187)
Lock washer	NASM35338-134	NASM35338-135
Material & Finish	303 stainless steel, passivated per QQ-P-35	
Individual packaging Souriau Space Grade (one package for one mated pair: 2 posts, 2 washers and 2 nuts)	8MCJP507NM	8MCJP517NM
ESA P/N (1 post + 1 washer + 1 nut)	3401084 03B	3401084 06B
P/N for packaging per 50 kits (one package for 50 mated pair: 100 posts, 100 washers and 100 nuts)	8MCJP507NM50	8MCJP517NM50

Jackposts for rear panel mounting

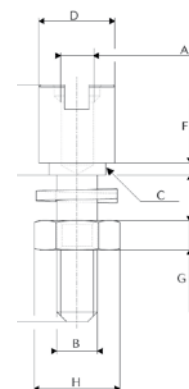
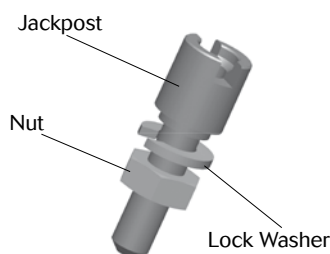
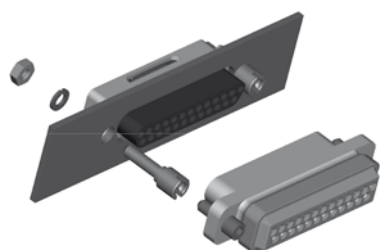

All dimensions in mm (*inches*)

Torque values: same as "Standard Jackposts"

For shell size A to H					
Panel thickness	0,8 mm (.031 in)	1,2 mm (.047 in)	1,6 mm (.063 in)	2,4 mm (.094 in)	3,2 mm (.126 in)
A thread size	#2-56 UNC-2B				
B thread size	#2-56 UNC-2A				
C max	Ø 3,0 (.118)				
D max	Ø 4,1 (.161)				
E	4,70/4,83 (.185/.190)				
F max	0,615 (.002)	1,09 (.042)	1,45 (.057)	2,23 (.087)	3,05 (.120)
G max	1,67 (.066)				
H max	4,0 (.157)				
Lock washer	NASM35338-134				
Material & Finish	303 stainless steel, passivated per QQ-P-35				
P/N for individual packaging (one package for one mated pair: 2 posts, 2 washers and 2 nuts)	8MCJP008NM	8MCJP012NM	8MCJP016NM	8MCJP024NM	8MCJP032NM
P/N for packaging per 50 kits (one package for 50 mated pair: 100 posts, 100 washers and 100 nuts)	8MCJP008NM50	8MCJP012NM50	8MCJP016NM50	8MCJP024NM50	8MCJP032NM50



Jackposts for rear panel mounting

For shell size J					
Panel thickness	0,8 mm (.031 in)	1,2 mm (.047 in)	1,6 mm (.063 in)	2,4 mm (.094 in)	3,2 mm (.126 in)
A thread size	#4-40 UNC-2B				
B thread size	#4-40 UNC-2A				
C max	Ø 3,6 (.141)				
D max	Ø 4,71 (.185)				
E	4,45/4,70 (.175/.185)				
F max	0,615 (.002)	1,09 (.042)	1,45 (.057)	2,23 (.087)	3,05 (.120)
G max	1.67 (.066)				
H max	4,0 (.157)				
Lock washer	NASM35338-135				
Material & Finish	303 stainless steel, passivated per QQ-P-35				
P/N for individual packaging (one package for one mated pair: 2 posts, 2 washers and 2 nuts)	8MCJP008NM	8MCJP512NM	8MCJP516NM	8MCJP524NM	8MCJP532NM
P/N for packaging per 50 kits (one package for 50 mated pair: 100 posts, 100 washers and 100 nuts)	8MCJP508NM50	8MCJP512NM50	8MCJP516NM50	8MCJP524NM50	8MCJP532NM50



Mounting hardware

Jackposts for PCB mounting (straight spills/PC tails):

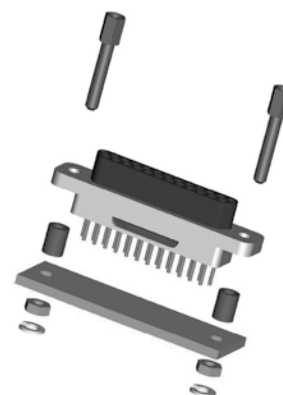
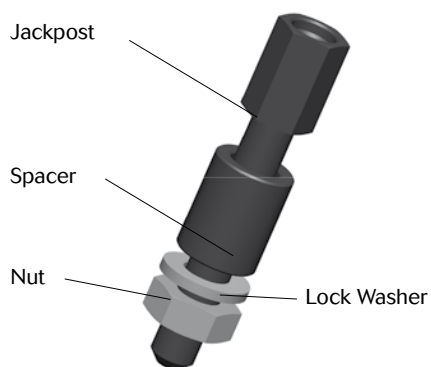

Torque values: same as "Standard Jackposts"

For shell size	A to H	J
A thread size	#2-56 UNC	#4-40 UNC
B hex size in mm (inch)	3,18 (.125)	4,75 (.187)
Lock washer	NASM35338-134	NASM35338-135
Material & Finish	303 stainless steel, passivated per QQ-P-35	
P/N for individual packaging (one package for one mated pair: 2 posts, 2 washers and 2 nuts)	8MCJPS070NM	8MCJPS170NM
P/N for packaging per 50 kits (one package for 50 mated pair: 100 posts, 100 washers and 100 nuts)	8MCJPS070NM50	8MCJPS170NM50
Jackpost		
Spacer		



Standard Jackscrews

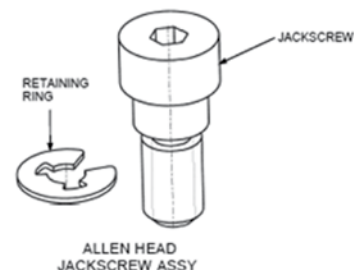
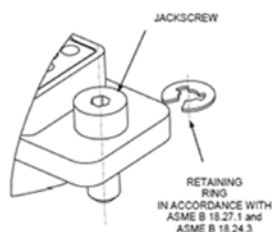

Torque values: same as "Standard Jackposts"

For shell size	A to H		J	
	#2-56 UNC		#4-40 UNC	
Dimensions in mm (<i>inch</i>)				
Head type	Allen head	Slot head	Allen head	Slot head
Material & Finish	303 stainless steel, passivated per QQ-P-35			
P/N for individual packaging (one package for one mated pair: 2 screws and 2 e-rings)	8MCJS502NM	8MCJS505NM	8MCJS512NM	8MCJS515NM
ESA P/N (1 screw and 1 e-rings)	3401084 01B	3401084 02B	3401084 04B	3401084 05B
P/N for packaging per 50 kits (one package for 50 mated pair: 100 screws and 100 e-rings)	8MCJS502NM50	8MCJS505NM50	8MCJS512NM50	8MCJS515NM50



Savers

Physical informations

Jackpost
(ordered separately)

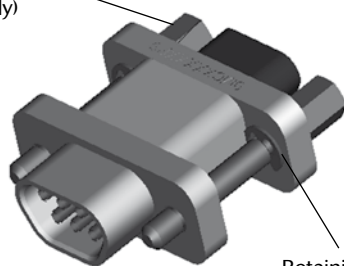

Retaining ring

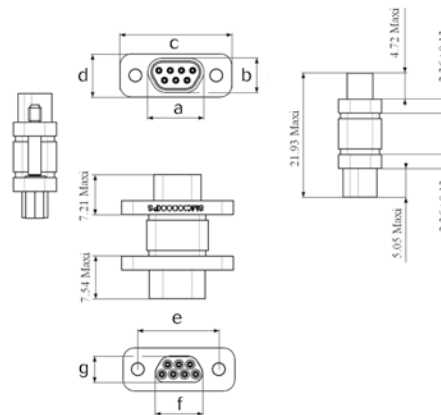

Shell Size	a		b		c		d		e		f	g	h
	Max	Max	min	Max	min	Max	min	Max	Max	Max	Max	min	
A	10.16 (.400)	6.38 (.251)	19.43 (.765)	19.94 (.785)	7.31 (.288)	7.82 (.307)	14.22 (.559)	14.48 (.570)	8.48 (.334)	4.69 (.185)	2.26 (.089)		
B	13.97 (.550)	6.38 (.251)	23.25 (.915)	23.75 (.935)	7.31 (.288)	7.82 (.307)	18.03 (.709)	18.29 (.720)	12.29 (.484)	4.69 (.185)	2.26 (.089)		
C	17.78 (.634)	6.38 (.251)	27.05 (1.065)	27.56 (1.085)	7.31 (.288)	7.82 (.307)	21.84 (.859)	22.10 (.870)	16.10 (.634)	4.69 (.185)	2.26 (.089)		
D	20.32 (.700)	6.38 (.251)	29.59 (1.165)	30.10 (1.185)	7.31 (.288)	7.82 (.307)	24.38 (.959)	24.64 (.970)	18.64 (.734)	4.69 (.185)	2.26 (.089)		
E	24.13 (.950)	6.38 (.251)	33.41 (1.315)	33.91 (1.335)	7.31 (.288)	7.82 (.307)	28.19 (1.149)	28.45 (1.120)	22.45 (.884)	4.69 (.185)	2.26 (.089)		
F	27.94 (1.100)	6.38 (.251)	37.21 (1.465)	37.72 (1.485)	7.31 (.288)	7.82 (.307)	32.00 (1.259)	32.26 (1.270)	26.26 (1.034)	4.69 (.185)	2.26 (.089)		
G	26.67 (1.050)	7.47 (.294)	35.95 (1.415)	36.45 (1.435)	8.42 (.331)	8.92 (.351)	30.73 (1.209)	30.99 (1.220)	24.99 (.934)	4.69 (.185)	2.26 (.089)		
H	38.65 (1.521)	7.47 (.294)	48.05 (1.891)	48.55 (1.911)	8.42 (.331)	8.92 (.351)	42.73 (1.682)	42.99 (1.692)	36.90 (1.463)	5.78 (.227)	2.26 (.089)		
J	46.80 (1.842)	10.94 (.431)	62.25 (2.451)	62.75 (2.470)	12.00 (.472)	12.50 (.492)	54.72 (2.154)	54.98 (1.377)	45.10 (1.775)	9.25 (.364)	3.70 (.146)		

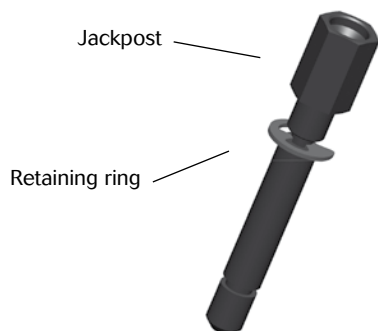

Jackpost

Retaining ring

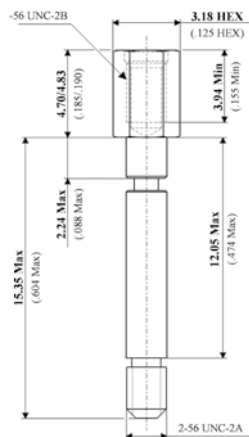

Size A to H

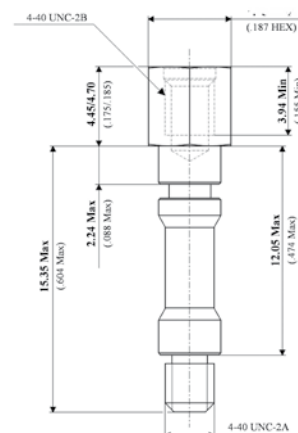

Size J



Savers

Ordering informations

microComp® savers series part numbering		8MCS	G	A7	PS
Shell Material	None: composite A: Aluminum				
Version:	G: Gold plating N: Nickel plating None: without plating				
Shell size & contacts layout:	A7: 7 contacts B11: 11 contacts* C13: 13 contacts D17: 17 contacts* E21: 21 contacts* F25: 25 contacts G33: 33 contacts* H51: 51 contacts J104: 104 contacts				
Pin socket contacts:	PS: male/female				

* Consult us for availability
 Jackpost kits are never included

Space Grade (SOURIAU P/N)			
Individual packaging (one package for one mated pair)			
Type		P/N	Description
Jackposts for savers	Size A-H	8MCJPA507NM	Jackpost Kit for <i>microComp</i> ® savers shell size A to H (2 jackposts + 2 e-ring).
	Size J	8MCJPA517NM	Jackpost Kit for <i>microComp</i> ® savers shell size J (2 jackposts + 2 e-ring).

Space Grade (SOURIAU P/N)			
Packaging per 50 kits (one package for 50 mated pair)			
Type		P/N	Description
Jackposts for savers	Size A-H	8MCJPA507NM50	Jackpost Kit for <i>microComp</i> ® savers shell size A to H (100 jackposts + 100 e-ring).
	Size J	8MCJPA517NM50	Jackpost Kit for <i>microComp</i> ® savers shell size J (100 jackposts + 100 e-ring).



EMI Backshells

Technical features

- SOURIAU Space Grade backshell kits consist of one low profile machined aluminum alloy backshell gold plated, two jackscrews (or jackposts) and two clips.
- Cable exits are designed for banded clamp termination. Once the braided copper shield is secure to the backshell the cable can be terminated with a heatshrink boot.
- Available with circular and/or elliptical entry, depending on shell size.
- Available with straight, 45° and 90° entry.
- For cable-to-box or cable-to-cable connection (for one cable-to-cable assembly, order one backshell with jackpost and one with jackscrew).
- Finish: 0.7 µm minimum of gold over a copper or electroless nickel base layer with a minimum thickness of 10 µm.

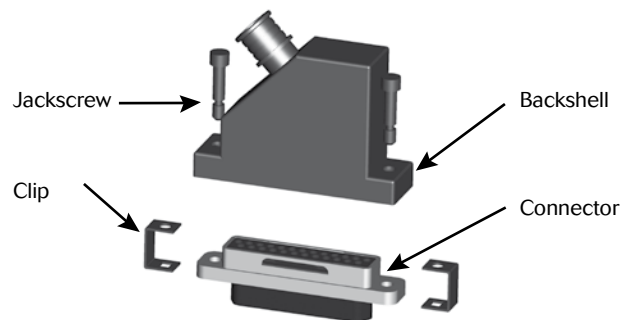

Cable entry size

Each backshell is available with 2 entry sizes, circular and/or elliptical

Shell size	Entry code	Entry shape	Circular entry size in mm (inch)	Elliptical entry size in mm (inch)		Entry surface in mm ² (inch ²)
			ø g	x ±0.15 (±.060)	y ±0.15(±.060)	
A-B	02	Circular	3,20 (.126)	-	-	8.04 (.012)
	03	Circular	4,80 (.189)	-	-	18.1 (.028)
C-D	03	Circular	4,80 (.189)	-	-	18.1 (.028)
	04	Circular	6,40 (.252)	-	-	32.17 (.05)
E-F	03	Circular	4,80 (.189)	-	-	18.1 (.028)
	05	Elliptical	-	10,80 (.425)	5,80 (.229)	49.2 (.076)
G	04	Circular	6,40 (.252)	-	-	32.17 (.05)
	06	Circular	9,50 (.374)	-	-	70.9 (.110)
H	05	Elliptical	-	10,80 (.425)	5,80 (.229)	49.2 (.076)
	07	Elliptical	-	21,00 (.827)	5,8 (.228)	95.7 (.148)
J	08	Elliptical	-	23,50 (.925)	6,80 (.268)	125.5 (.195)
	10	Elliptical	-	33,00 (1.3)	7,8 (.307)	202.15 (.313)



EMI Backshells

Straight backshell

Straight backshell	8MCBS	F	001	03	G
Shell size:	A - B - C - D - E - F - G - H - J				
Environment:	None: for connector without grommet				
Straight version:	001				
Cable entry type:	see «Cable entry size» table				
Finish:	G: gold				
Mounting hardware:	None: jackscrews (standard use) F: jackposts (for cable to cable connection only)				

Backshells are always supplied with 2 clips and 2 jackscrews or jackposts

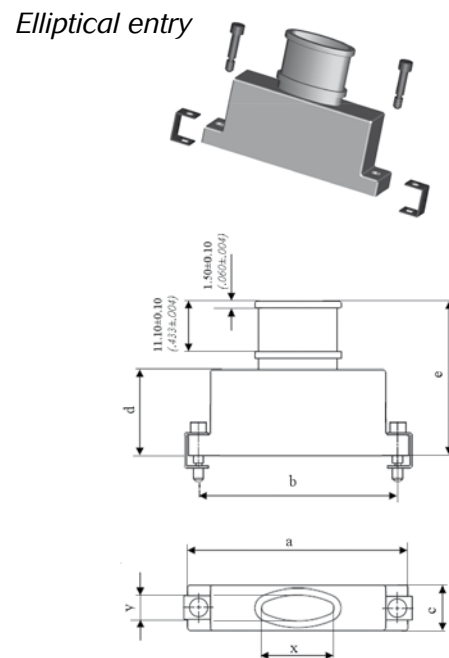
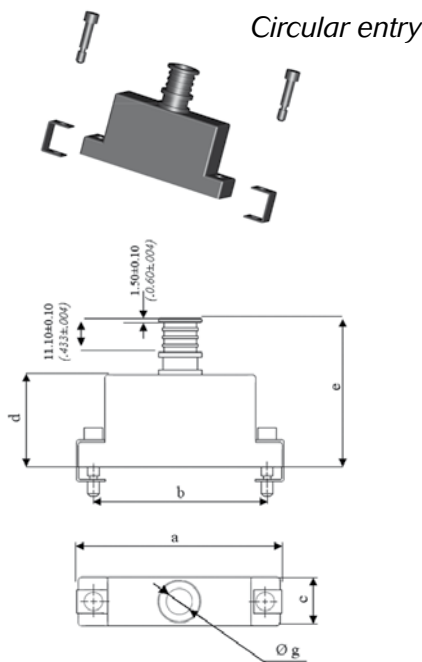

Shell Size	A	B	C	D	E	F	G	H	J
a ±0.15 (±060)	19,70 (.776)	23,40 (.921)	27,30 (1.075)	29,85 (1.176)	33,70 (1.327)	37,50 (1.476)	36,10 (1.421)	48,85 (1.923)	62,80 (2.473)
b ±0.13 (±051)	14,35 (.565)	18,16 (.715)	21,97 (.865)	24,51 (.965)	28,32 (1.115)	32,13 (1.265)	30,86 (1.215)	43,36 (1.707)	54,85 (2.160)
c ±0.15 (±060)	9,00 (.354)	9,00 (.354)	9,00 (.354)	9,00 (.354)	9,00 (.354)	9,00 (.354)	10,00 (.394)	10,00 (.395)	13,00 (.512)
d Max.	10,00 (.394)	12,00 (.472)	14,00 (.551)	16,00 (.623)	17,00 (.670)	18,00 (.709)	19,00 (.748)	19,00 (.748)	21,00 (.827)
e Max.									

Max weight in g (oz)	3,50 (0.12)	3,80 (0.13)	5,00 (0.18)	5,60 (0.20)	7,00 (0.25)	7,70 (0.27)	9,20 (0.32)	9,50 (0.34)	14,50 (0.51)
-------------------------	----------------	----------------	----------------	----------------	----------------	----------------	----------------	----------------	-----------------

All dimensions in mm (inches)



45° backshell

45° backshell	8MCBS	F	101	03	G
Shell size:	A - B - C - D - E - F - G - H - J				
Environment:	None: for connector without grommet				
45° version:	101				
Cable entry type:	see «Cable entry size» table				
Finish:	G: gold				
Mounting hardware:	None: jackscrews (standard use) F: jackposts (for cable to cable connection only)				

Backshells are always supplied with 2 clips and 2 jackscrews or jackposts

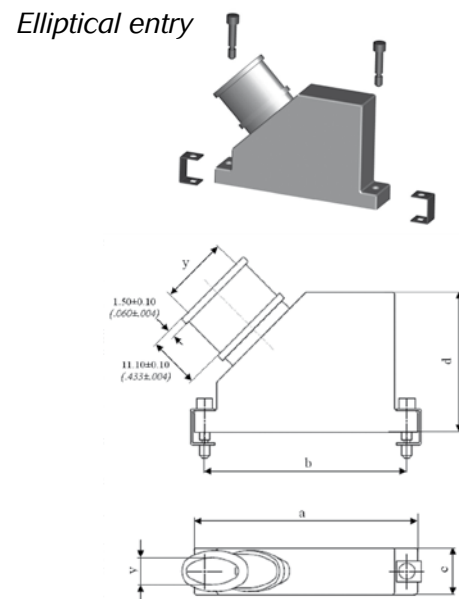
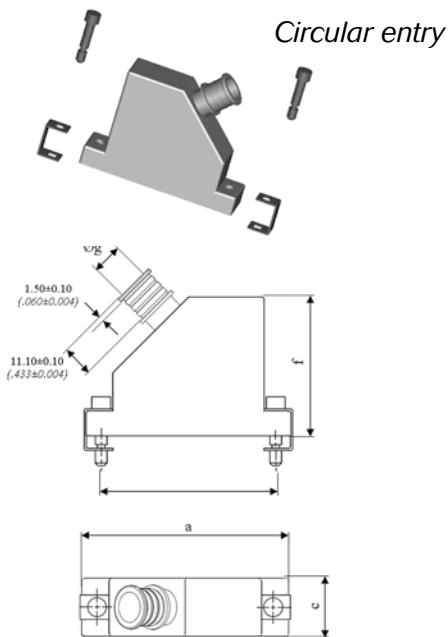

Shell Size	A	B	C	D	E	F	G	H	J
a ±0.15 (±060)	19,70 (.776)	23,40 (.921)	27,30 (1.075)	29,85 (1.176)	33,70 (1.327)	37,50 (1.476)	36,10 (1.421)	48,85 (1.923)	62,80 (2.473)
b ±0.13 (±051)	14,35 (.565)	18,16 (.715)	21,97 (.865)	24,51 (.965)	28,32 (1.115)	32,13 (1.265)	30,86 (1.215)	43,36 (1.707)	54,85 (2.160)
c ±0.15 (±060)	9,00 (.354)	9,00 (.354)	9,00 (.354)	9,00 (.354)	9,00 (.354)	9,00 (.354)	10,00 (.394)	10,00 (.395)	13,00 (.512)
d Max.	10,00 (.394)	12,00 (.472)	14,00 (.551)	16,00 (.623)	17,00 (.670)	18,00 (.709)	19,00 (.748)	23,00 (.905)	25,00 (.984)
f Max.	21,00 (.827)	23,00 (.906)	25,00 (.984)	27,00 (1.063)	28,00 (1.102)	29,00 (1.142)	30,00 (1.181)	30,00 (1.058)	38,00 (1.340)

Max weight in g (oz)	5,20 (0.18)	6,20 (0.22)	7,35 (0.26)	8,45 (0.30)	9,25 (0.33)	10,70 (0.38)	11,45 (0.40)	12,00 (0.42)	19,00 (0.67)
-------------------------	----------------	----------------	----------------	----------------	----------------	-----------------	-----------------	-----------------	-----------------

All dimensions in mm (inches)



EMI Backshells

90° backshell

90° backshell	8MCBS	F	201	03	G
Shell size:	A - B - C - D - E - F - G - H - J				
Environment:	None: for connector without grommet				
90° version:	201				
Cable entry type:	see «Cable entry size» table				
Finish:	G: gold				
Mounting hardware:	None: jackscrews (standard use) F: jackposts (for cable to cable connection only)				

Backshells are always supplied with 2 clips and 2 jackscrews or jackposts

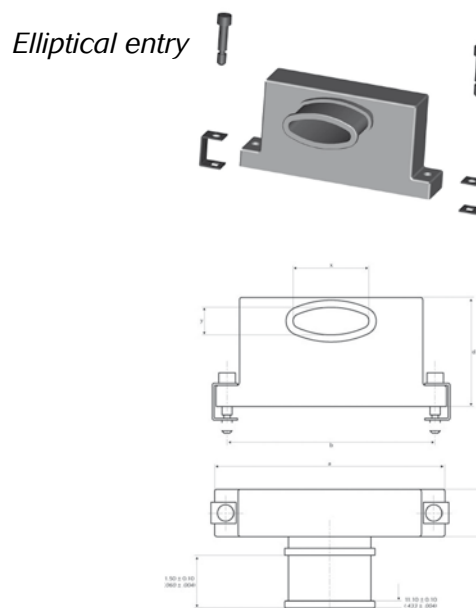
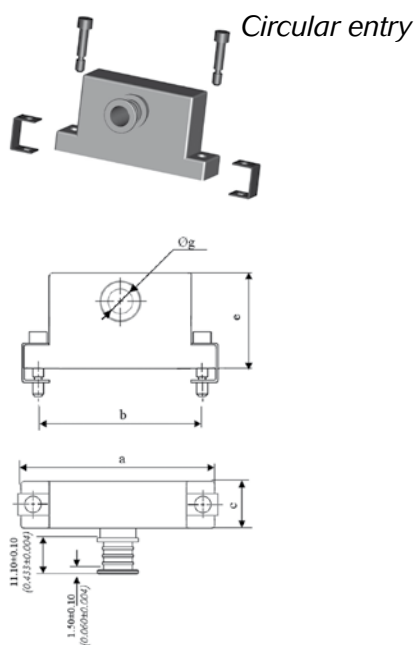

Shell Size	A	B	C	D	E	F	G	H	J
a ±0.15 (±060)	19,70 (.776)	23,40 (.921)	27,30 (1.075)	29,85 (1.176)	33,70 (1.327)	37,50 (1.476)	36,10 (1.421)	48,85 (1.923)	62,80 (2.473)
b ±0.13 (±051)	14,35 (.565)	18,16 (.715)	21,97 (.865)	24,51 (.965)	28,32 (1.115)	32,13 (1.265)	30,86 (1.215)	43,36 (1.707)	54,85 (2.160)
c ±0.15 (±060)	9,00 (.354)	9,00 (.354)	9,00 (.354)	9,00 (.354)	9,00 (.354)	9,00 (.354)	10,00 (.394)	10,00 (.395)	13,00 (.512)
d Max.	10,00 (.394)	12,00 (.472)	14,00 (.551)	16,00 (.623)	17,00 (.670)	18,00 (.709)	19,00 (.748)	23,00 (.905)	25,00 (.984)

Max weight in g (oz)	5,13 (.18)	6,20 (.22)	7,31 (.26)	8,44 (.30)	9,25 (.33)	10,44 (.38)	11,44 (.40)	12,00 (.42)	19,00 (.67)
-------------------------	---------------	---------------	---------------	---------------	---------------	----------------	----------------	----------------	----------------

All dimensions in mm (inches)



ESA part numbers

ESA series - EMI Backshells	3 401 084	09	B
Variant:	See table below		
Testing Level	B		

Cross-reference ESA / SOURIAU part numbers

	SOURIAU P/N	ESA P/N	Description	Max weight in g (w/o clip, jackpost, jackscrew)
Size A to G	8MCBS A 001 02 G	3 401 084 09 B	Straight with male jackscrews and clips, size A	2,7
	8MCBS B 001 02 G	3 401 084 10B	Straight with male jackscrews and clips, size B	3
	8MCBS C 001 02 G	3 401 084 11 B	Straight with male jackscrews and clips, size C	3,95
	8MCBS D 001 03 G	3 401 084 12 B	Straight with male jackscrews and clips, size D	4,75
	8MCBS E 001 03 G	3 401 084 13 B	Straight with male jackscrews and clips, size E	5,5
	8MCBS F 001 03 G	3 401 084 14 B	Straight with male jackscrews and clips, size F	6,15
	8MCBS G 001 04 G	3 401 084 15 B	Straight with male jackscrews and clips, size G	7,35
	8MCBS A 001 02 G F	3 401 084 16 B	Straight with female jackposts, size A	2,7
	8MCBS B 001 02 G F	3 401 084 17 B	Straight with female jackposts, size B	3
	8MCBS C 001 02 G F	3 401 084 18 B	Straight with female jackposts, size C	3,95
	8MCBS D 001 03 G F	3 401 084 19 B	Straight with female jackposts, size D	4,75
	8MCBS E 001 03 G F	3 401 084 20 B	Straight with female jackposts, size E	5,5
	8MCBS F 001 03 G F	3 401 084 21 B	Straight with female jackposts, size F	6,15
	8MCBS G 001 04 G F	3 401 084 22 B	Straight with female jackposts, size G	7,35
	8MCBS A 101 02 G	3 401 084 23 B	45° with male jackscrews and clips, size A	4,1
	8MCBS B 101 02 G	3 401 084 24 B	45° with male jackscrews and clips, size B	4,95
	8MCBS C 101 02 G	3 401 084 25 B	45° with male jackscrews and clips, size C	5,85
	8MCBS D 101 03 G	3 401 084 26 B	45° with male jackscrews and clips, size D	6,75
	8MCBS E 101 03 G	3 401 084 27 B	45° with male jackscrews and clips, size E	7,4
	8MCBS F 101 03 G	3 401 084 28 B	45° with male jackscrews and clips, size F	8,55
	8MCBS G 101 04 G	3 401 084 29 B	45° with male jackscrews and clips, size G	9,15
	8MCBS A 101 02 G F	3 401 084 30 B	45° with female jackposts, size A	4,1
	8MCBS B 101 02 G F	3 401 084 31 B	45° with female jackposts, size B	4,95
	8MCBS C 101 02 G F	3 401 084 32 B	45° with female jackposts, size C	5,85
	8MCBS D 101 03 G F	3 401 084 33 B	45° with female jackposts, size D	6,75
	8MCBS E 101 03 G F	3 401 084 34 B	45° with female jackposts, size E	7,4
	8MCBS F 101 03 G F	3 401 084 35 B	45° with female jackposts, size F	8,55
	8MCBS G 101 04 G F	3 401 084 36 B	45° with female jackposts, size G	9,15



EMI Backshells

Cross-reference ESA / SOURIAU part numbers

	SOURIAU P/N	ESA P/N	Description	Max weight in g (w/o clip, jackpost, jackscrew)
Size A to G	8MCBS A 201 02 G	3 401 084 37 B	90° with male jackscrews and clips, size A	4,1
	8MCBS B 201 02 G	3 401 084 38 B	90° with male jackscrews and clips, size B	4,95
	8MCBS C 201 02 G	3 401 084 39 B	90° with male jackscrews and clips, size C	5,85
	8MCBS D 201 03 G	3 401 084 40 B	90° with male jackscrews and clips, size D	6,75
	8MCBS E 201 03 G	3 401 084 41 B	90° with male jackscrews and clips, size E	7,4
	8MCBS F 201 03 G	3 401 084 42 B	90° with male jackscrews and clips, size F	8,35
	8MCBS G 201 04 G	3 401 084 43 B	90° with male jackscrews and clips, size G	9,15
	8MCBS A 201 02 G F	3 401 084 44 B	90° with female jackposts, size A	4,1
	8MCBS B 201 02 G F	3 401 084 45 B	90° with female jackposts, size B	4,95
	8MCBS C 201 02 G F	3 401 084 46 B	90° with female jackposts, size C	5,85
	8MCBS D 201 03 G F	3 401 084 47 B	90° with female jackposts, size D	6,75
	8MCBS E 201 03 G F	3 401 084 48 B	90° with female jackposts, size E	7,4
	8MCBS F 201 03 G F	3 401 084 49 B	90° with female jackposts, size F	8,35
	8MCBS G 201 04 G F	3 401 084 50 B	90° with female jackposts, size G	9,15
Size H and J	8MCBS H 001 05 G	3 401 084 51 B	Straight with male jackscrews and clips, size H	7,5
	8MCBS J 001 08 G	3 401 084 52 B	Straight with male jackscrews and clips, size J	11,5
	8MCBS H 001 05 G F	3 401 084 53 B	Straight with female jackposts, size H	7,5
	8MCBS J 001 08 G F	3 401 084 54 B	Straight with female jackposts, size J	11,5
	8MCBS H 101 05 G	3 401 084 55 B	45° with male jackscrews and clips, size H	9,5
	8MCBS J 101 08 G	3 401 084 56 B	45° with male jackscrews and clips, size J	15,2
	8MCBS H 101 05 G F	3 401 084 57 B	45° with female jackposts, size H	9,5
	8MCBS J 101 08 G F	3 401 084 58 B	45° with female jackposts, size J	15,2
	8MCBS H 201 05 G	3 401 084 59 B	90° with male jackscrews and clips, size H	9,5
	8MCBS J 201 08 G	3 401 084 60 B	90° with male jackscrews and clips, size J	15,2
	8MCBS H 201 05 G F	3 401 084 61 B	90° with female jackposts, size H	9,5
	8MCBS J 201 08 G F	3 401 084 62 B	90° with female jackposts, size J	15,2



Dust Caps

Molded plastic dust caps

- Anti-static dust caps in rugged plastic material that resists cracking
- Material : Polypropylene
- Color : black.

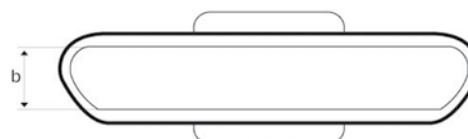
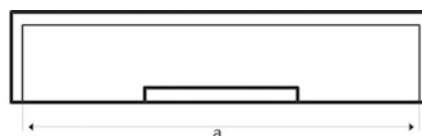
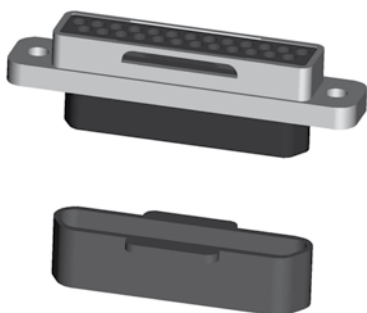

Shell size	Gender	Part number	a	b
A	P (male)	8MC DC AP	8 (.315)	4,7 (.184)
	S (female)	8MC DC AS	9,8 (.385)	6,4 (.250)
B	P	8MC DC BP	11,8 (.465)	4,7 (.184)
	S	8MC DC BS	13,6 (.535)	6,4 (.250)
C	P	8MC DC CP	15,6 (.615)	4,7 (.184)
	S	8MC DC CS	17,4 (.685)	6,4 (.250)
D	P	8MC DC DP	18,2 (.715)	4,7 (.184)
	S	8MC DC DS	19,9 (.785)	6,4 (.250)
E	P	8MC DC EP	22 (.865)	4,7 (.184)
	S	8MC DC ES	23,7 (.935)	6,4 (.250)
F	P	8MC DC FP	25,8 (1.015)	4,7 (.184)
	S	8MC DC FS	27,6 (1.085)	6,4 (.250)
G	P	8MC DC GP	24,5 (.965)	5,8 (.227)
	S	8MC DC GS	26,3 (1.035)	7,4 (.292)
H	P	8MC DC HP	37,9 (1.492)	5,8 (.228)
	S	8MC DC HS	38,8 (1.528)	7,4 (.291)
J	P	8MC DC JP	45,2 (1.78)	9,35 (.368)
	S	8MC DC JS	46,8 (1.843)	11 (.433)

All dimensions in mm (inches)

Reliable People, Reliable Solutions

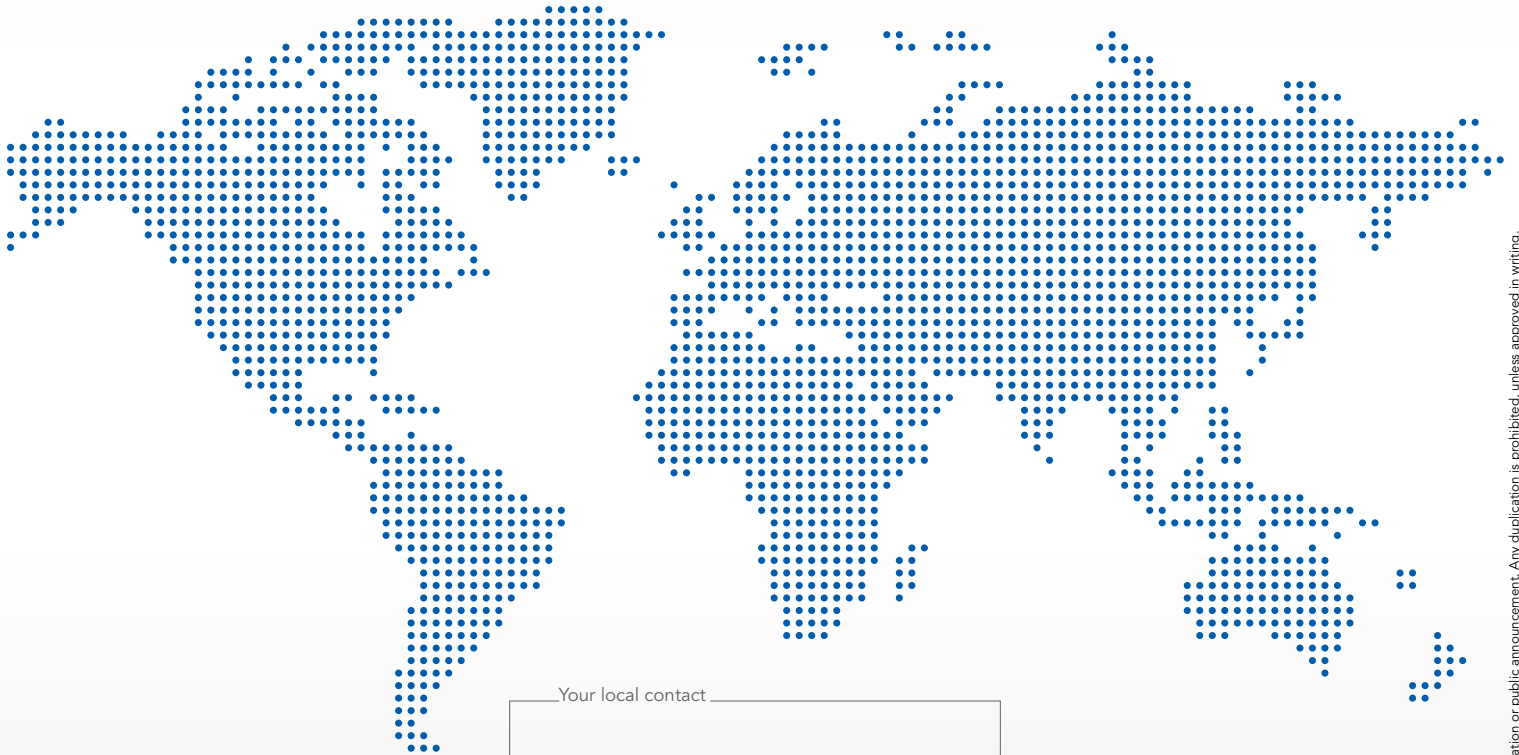

Your local contact



Our contribution to environmental protection:
This catalog is printed on PEFC certified paper
Advancement of sustainable wood cultivation. www.pefc.org

www.esterline-connection-technologies.com
technical-emear-ect@esterline.com (Europe - Asia - Africa)
technical-americas-ect@esterline.com (North America)



SOURIAU